

# **IntesisBox**®

## HS-RC-MBS-1

Modbus RTU (EIA-485) Interface for Hisense air conditioners.  
Compatible with commercial line of air conditioners commercialized  
by Hisense.

## User Manual

Issue Date: 04/2019  
r1.5 EN

Order Codes:

**HS-RC-MBS-1:** Modbus RTU Interface for Hisense air conditioners

**© Intesis Software S.L.U. All Rights Reserved.**

Information in this document is subject to change without notice. No part of this publication may be reproduced, stored in a retrieval system or transmitted in any form or any means electronic or mechanical, including photocopying and recording for any purpose other than the purchaser's personal use without the written permission of Intesis Software S.L.U.

Intesis Software S.L.U.  
Milà i Fontanals, 1 bis  
08700 Igualada  
Spain

**TRADEMARKS**

All trademarks and tradenames used in this document are acknowledged to be the copyright of their respective holders.

**INDEX**

1. Presentation ..... 4

2. Connection ..... 5

    2.1 Connect to the AC indoor unit ..... 5

    2.2 Connection to the EIA-485 bus ..... 6

3. Quick Start Guide..... 6

4. Modbus Interface Specification ..... 7

    4.1 Modbus physical layer..... 7

    4.2 Modbus Registers..... 7

        4.2.1 Control and status registers ..... 7

        4.2.2 Configuration Registers..... 9

        4.2.3 Considerations on Temperature Registers ..... 9

    4.3 DIP-switch Configuration Interface ..... 12

    4.4 Implemented Functions ..... 15

    4.5 Device LED indicator..... 15

    4.6 EIA-485 bus. Termination resistors and Fail Safe Biasing mechanism ..... 16

5. Electrical and Mechanical features ..... 17

6. List of supported AC Unit Types. .... 18

7. Error Codes ..... 19

## 1. Presentation



The HS-RC-MBS-1 interfaces allow a complete and natural integration of **Hisense** air conditioners into Modbus RTU (EIA-485) networks.

Compatible with commercial line of air conditioners commercialized by Hisense.

Reduced dimensions. 93 x 53 x 58 mm  
3.7" x 2.1" x 2.3"

- Quick and easy installation.  
*Mountable on DIN rail, wall, or even inside the indoor unit of AC.*
- External power not required.
- Direct connection to Modbus RTU (EIA-485) networks. Up to 63 HS-RC-MBS-1 devices can be connected in the same network.  
*HS-RC-MBS-1 is a Modbus slave device.*
- Direct connection to the AC indoor unit. Up to 16 AC indoor units can be connected to HS-RC-MBS-1, controlling them as one (not individually).
- Configuration from both on-board DIP-switches and Modbus RTU.
- Total Control and Supervision.
- Real states of the AC unit's internal variables.
- Allows simultaneous use of the AC's remote controls and Modbus RTU.

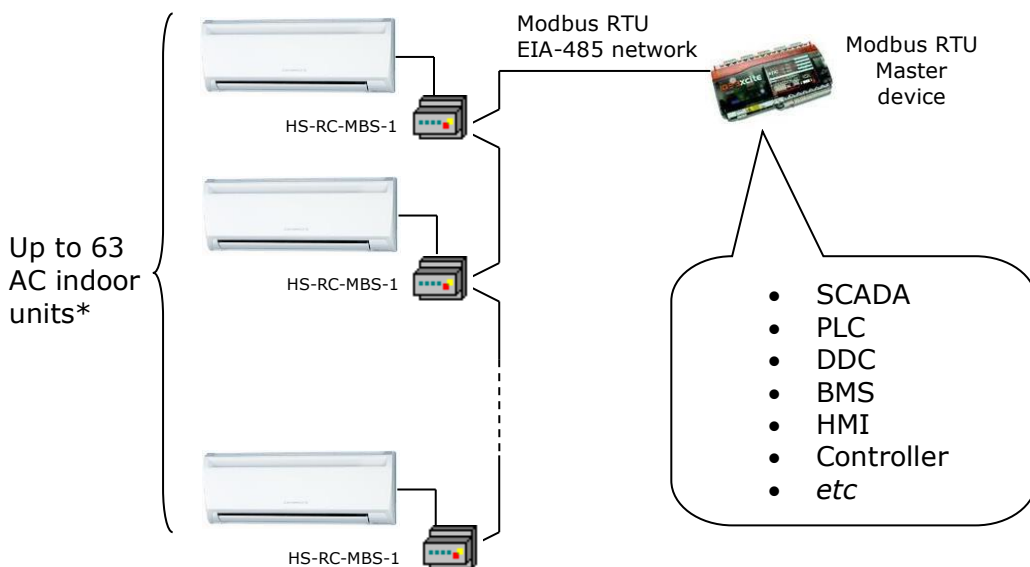

\* Up to 63 IntesisBox devices can be installed in the same Modbus RTU bus. However, depending on the configured speed, the installation of Modbus Repeaters may be required

## 2. Connection

The interface comes with a plug-in terminal block of 2 poles to establish direct connection with the AC indoor unit. It comes as well with a plug-in terminal block of 2 poles to establish direct connection with the Modbus RTU EIA-485 network.

### 2.1 Connect to the AC indoor unit

The HS-RC-MBS-1 connects directly to the Hisense AB Bus, which is not provided within the interface. Depending on which controllers are available, the recommended connection' methods are the following ones (details in Figure 2. 1):

- **Wired remote control available.** Connect the gateway as Slave in parallel with the wired remote controllers (Controller acts as Master).
- **No remote control available** Connect the gateway directly to the AB bus of the indoor unit as Master when there is no Hisense Remote Controller.

**Important:** If there is more than one AC unit connected to the same AB bus, it is required to install a Hisense wired Remote Controller (set as Master of the bus)

Maximum AB bus length is 500 m / 1,640.42 ft. The bus has no polarity sensitivity.

**Important:** If a wired remote controller of the AC manufacturer is connected in the same bus, communication may shut down.

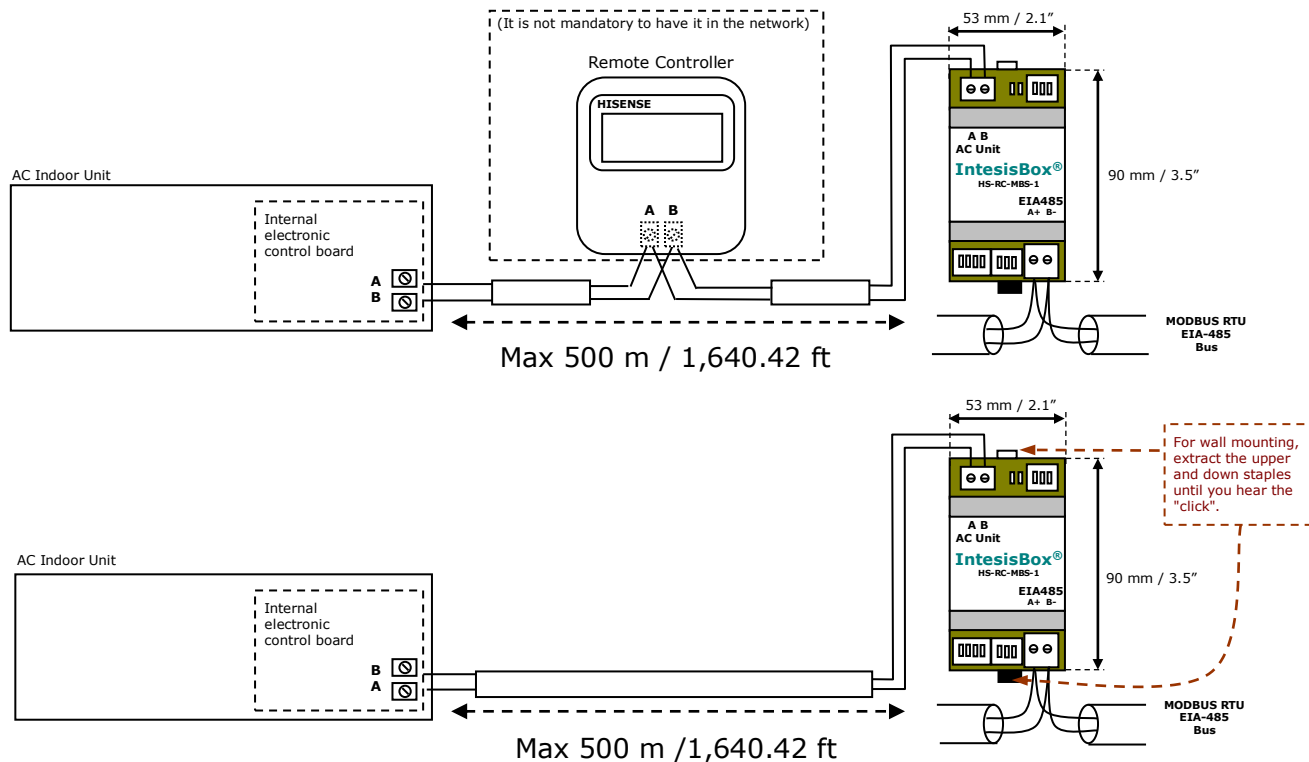

Figure 2. 1 HS-RC-MBS-1 connection diagram

## 2.2 Connection to the EIA-485 bus

Connect the EIA-485 bus wires to the plug-in terminal block of HS-RC-MBS-1 and keep the polarity on this connection (A+ and B-). Make sure that the maximum distance to the bus is 1,200 meters (3,937 ft). Loop or star typologies are not allowed in the case of the EIA-485 bus. A terminator resistor of 120Ω must be present at each end of the bus to avoid signal reflections. The bus needs a fail-safe biasing mechanism (see section 4.6 for more details).

## 3. Quick Start Guide

1. Disconnect the air conditioning from the Mains Power.
2. Attach the interface next to the AC indoor unit (wall mounting) following the instructions of the diagram below or install it inside the AC indoor unit (respect the safety instructions given).
3. Connect the AB bus between the interface and the AC indoor unit following the instructions of the diagram. Screw each bare cable end in the corresponding AB terminals of each device.
4. Connect the EIA-485 bus to the connector *EIA485* of the interface.
5. Close the AC indoor unit.
6. Check the DIP-Switch configuration of the IntesisBox interface and make sure it matches the current installation's parameters (see section 4.3).

By default, the interface is set to:

- Modbus Slave Address → 1
- Modbus baud rate → 9600 bps



These parameters can be modified from SW4 and SW3 DIP-Switches.

All other switch positions are set at low level (Off position ) by default.

**NOTE:** All changes on the DIP-Switch configuration require a system power cycle to be applied.

7. Connect the AC system to Mains Power.

**IMPORTANT:** The IntesisBox interface requires to be connected to the AC unit (powered) to start communicating.

## 4. Modbus Interface Specification

### 4.1 Modbus physical layer

HS-RC-MBS-1 implements a Modbus RTU (Slave) interface, to be connected to an EIA-485 line. It performs 8N2 communication (8 data bits, no parity and 2 stop bit) with several available baud rates (2400 bps, 4800 bps, 9600 bps -default-, 19200 bps, 38400 bps, 57600 bps, 76800 bps and 115200 bps). It also supports 8N1 communication (8 data bits, no parity and 1 stop bit).

### 4.2 Modbus Registers

All registers are type "16-bit unsigned Holding Register" and they use the standard *Modbus big endian* notation.

#### 4.2.1 Control and status registers

Register Address (protocol address)	Register Address (PLC address)	R/W	Description
0	1	R/W	AC unit On/Off <ul style="list-style-type: none"> <li>▪ 0: Off</li> <li>▪ 1: On</li> </ul>
1	2	R/W	AC unit Mode <sup>1</sup> <ul style="list-style-type: none"> <li>▪ 0: Auto</li> <li>▪ 1: Heat</li> <li>▪ 2: Dry</li> <li>▪ 3: Fan</li> <li>▪ 4: Cool</li> </ul>
2	3	R/W	AC unit Fan Speed <sup>1</sup> <ul style="list-style-type: none"> <li>▪ 0: Auto</li> <li>▪ 1: Low</li> <li>▪ 2: Mid</li> <li>▪ 3: High</li> <li>▪ 4: Super-high</li> </ul>
3	4	R/W	AC unit Vane Position <sup>1</sup> <ul style="list-style-type: none"> <li>▪ 1: POS1 (Horizontal)</li> <li>▪ 2: POS2 (Horizontal)</li> <li>▪ 3: POS3 (Med)</li> <li>▪ 4: POS4 (Vert)</li> <li>▪ 5: POS5 (Vert)</li> <li>▪ 6: POS6</li> <li>▪ 7: POS7</li> <li>▪ 10: Swing</li> </ul>
4	5	R/W	AC unit Temperature Setpoint <sup>1,2,3</sup> <ul style="list-style-type: none"> <li>▪ -32768 (Initialization value)</li> <li>▪ 16..32°C (°C/x10°C)</li> <li>▪ 61..90°F</li> </ul>

<sup>1</sup> Available values will depend on the AC unit mode. Check the AC unit model functions in its user manual to know the possible values for this register.

<sup>2</sup> Magnitude for this register can be adjusted to Celsius x 1°C, Celsius x 10°C (default) or Fahrenheit. See section 4.2.3 for more information.

<sup>3</sup> It is not possible turn to x10 the value shown in Fahrenheit.

Register Address (protocol address)	Register Address (PLC address)	R/W	Description
5	6	R	AC unit Temperature reference <sup>1,2,3</sup> <ul style="list-style-type: none"> <li>-32768 (Initialization value)</li> <li>Ranges are specific from Manufacturer(°C/x10°C/°F)</li> </ul>
6	7	R/W	Window Contact <ul style="list-style-type: none"> <li>0: Closed (Default value)</li> <li>1: Open</li> </ul>
7	8	R/W	HS-RC-MBS-1 Disablement <sup>4</sup> <ul style="list-style-type: none"> <li>0: HS-RC-MBS-1 enabled (Default value)</li> <li>1: HS-RC-MBS-1 disabled</li> </ul>
8	9	R/W	AC Remote Control Disablement <sup>4</sup> <ul style="list-style-type: none"> <li>0: Remote Control enabled (Default value)</li> <li>1: Remote Control disabled</li> </ul>
9	10	R/W	AC unit Operation Time <sup>4</sup> <ul style="list-style-type: none"> <li>0..65535 (hours). Counts the time the AC unit is in "On" state.</li> </ul>
10	11	R	AC unit Alarm Status <ul style="list-style-type: none"> <li>0: No alarm condition</li> <li>1: Alarm condition</li> </ul>
11	12	R	Error Code <sup>5</sup> <ul style="list-style-type: none"> <li>0: No Error</li> <li>65535 (-1): Error in the communication of HS-RC-MBS-1 or Remote Controller with the AC unit.</li> <li>Any other error present, see the table at the end of this document.</li> </ul>
22	23	R/W	Indoor unit's ambient temperature from external sensor (at Modbus side) <sup>1,2,3,6</sup> <ul style="list-style-type: none"> <li>-32768: (Initialization value). No temperature is being provided from an input sensor. There's no input sensor.</li> <li>Any other: (°C/x10°C/°F)</li> </ul>
23	24	R	AC Real temperature setpoint <sup>1,2,3,6</sup> <ul style="list-style-type: none"> <li>-32768 (Initialization value)</li> <li>16..31°C (°C/x10°C)</li> <li>60..90°F</li> </ul>
24	25	R	Current AC max setpoint <sup>1,2,3</sup> <ul style="list-style-type: none"> <li>-32768 (Initialization value)</li> <li>Ranges are specific from Manufacturer (°C/x10°C/°F)</li> </ul>
25	26	R	Current AC min setpoint <sup>1,2,3</sup> <ul style="list-style-type: none"> <li>-32768 (Initialization value)</li> <li>Ranges are specific from Manufacturer (°C/x10°C/°F)</li> </ul>
31	32	R	Status (feedback) <ul style="list-style-type: none"> <li>0: Not active (Default value)</li> <li>1: Active (A window is open)</li> </ul>
34	35	W	Left/Right Vane pulse <ul style="list-style-type: none"> <li>1: Pulse</li> </ul>

<sup>4</sup> This value is stored in non-volatile memory

<sup>5</sup> See section 7 for possible error codes and their explanation

<sup>6</sup> See section 4.2.3 for more information



Register Address (protocol address)	Register Address (PLC address)	R/W	Description
66	67	R	Return Path temperature <sup>1,2,3</sup> <ul style="list-style-type: none"> <li>-32768 (Initialization value)</li> <li>Any: (°C/x10°C/°F)</li> </ul>
98	99	R/W	Master/Slave (gateway) <ul style="list-style-type: none"> <li>0: Slave</li> <li>1: Master</li> </ul>

### 4.2.2 Configuration Registers

Register Address (protocol address)	Register Address (PLC address)	R/W	Description
13	14	R/W	"Open Window" switch-off timeout <sup>7</sup> <ul style="list-style-type: none"> <li>0..30 (minutes)</li> <li>Factory setting: 30 (minutes)</li> </ul>
14	15	R	Modbus RTU baud-rate <ul style="list-style-type: none"> <li>2400bps</li> <li>4800bps</li> <li>9600bps (Default)</li> <li>19200bps</li> <li>38400bps</li> <li>57600bps</li> <li>76800bps</li> <li>115200bps</li> </ul>
15	16	R	Modbus Slave Address <ul style="list-style-type: none"> <li>1..63</li> </ul>
21	22	R	Max number of fan speeds
45	46	W	Error reset <ul style="list-style-type: none"> <li>1: Reset</li> </ul>
48	49	R	Switch value
49	50	R	Device ID: 0x2B00
50	51	R	Software version
81	82	R	Error address <ul style="list-style-type: none"> <li>Provides the indoor unit number which is providing error</li> </ul>
99	100	W	Reset <ul style="list-style-type: none"> <li>1: Reset</li> </ul>

### 4.2.3 Considerations on Temperature Registers

- AC unit temperature setpoint (R/W)**  
 (register 4 – in Protocol address / register 5 – in PLC address):  
 This is the adjustable temperature setpoint value that must be required by the user. This register can be read (Modbus function 3 or 4) or written (Modbus functions 6 or 16). A Remote Controller connected to the Hisense indoor unit will report the same temperature setpoint value as this register, but only will happen when no AC unit's external reference is provided from HS-RC-MBS-1 (see detail for register 22/23 below).

<sup>7</sup> Once window contact is open, a count-down to switch off the AC Unit will start from this configured value.

- **AC unit temperature reference (R)**  
(register 5 – in Protocol address / register 6 – in PLC address):  
This register reports the temperature that is currently used by the Hisense indoor unit as the reference of its own control loop. Depending on the configuration of the indoor unit, this value can be the temperature reported by the sensor on the return path of the Hisense indoor unit or the sensor of its remote controller. It is a read-only register (Modbus functions 3 or 4).
- **AC unit external temperature reference (Modbus) (R/W)**  
(register 22 – in Protocol address / register 23 – in PLC address):  
This register allows us to provide an external temperature's sensor from the Modbus side. The Hisense indoor unit does not allow on devices like HS-RC-MBS-1 to provide directly temperature to be used as a reference of the control loop of the AC indoor unit. In order to overcome this limitation and enable the usage of an external temperature sensor (i.e. from Modbus side), HS-RC-MBS-1 applies the following mechanism (only if "external temperature's reference" is being used):
  - After a couple of values have been entered in the "AC unit external temperature's reference" (register 22/23) and "AC unit temperature set point" (register 4/5), HS-RC-MBS-1 is going to estimate the temperature chosen implied (e.g. if a "temperature setpoint (register 4/5)" of **22°C**, and an "external temperature reference (register 22/23)" of **20°C** are entered, HS-RC-MBS-1 will assume that the user is demanding a **+2°C** increase in temperature).
  - By knowing at any time the ambient temperature currently used by the indoor unit to control its own operation (register 5/6), HS-RC-MBS-1 can calculate the required temperature setpoint needed to apply the decrease/increase on the real temperature and reach the temperature chosen by the user (following the example above, if HS-RC-MBS-1 reads an "ambient temperature" (register 5/6) of **24°C** in the indoor unit, it will apply a final setpoint of **24°C + 2°C = 26°C**).
  - At this moment, each time that HS-RC-MBS-1 detects a change on the ambient temperature reported by the indoor unit (register 5/6), it will also change the required setpoint, in order to keep the temperature required by the user at any time. If we follow the last example, if HS-RC-MBS-1 receives a new temperature's value coming from the indoor unit of **25°C**, HS-RC-MBS-1 will automatically adjust the temperature setpoint required of the AC indoor unit to **25°C + 2°C = 27°C**).
  - In general, HS-RC-MBS-1 is constantly applying the the "Virtual Temperature" formula:

$$S_{AC} = S_u - (T_u - T_{AC})$$

Where:

- $S_{AC}$  - setpoint value currently applied to the indoor unit
- $S_u$  - setpoint value (register 4/5)
- $T_u$  - external temperature reference written at Modbus side (register 22/23)
- $T_{AC}$  - ambient temperature that the indoor unit is using as the reference of its own control loop (register 5/6)

When HS-RC-MBS-1 detects a change in any of the values of  $\{ S_u, T_u, T_{AC} \}_r$ , it will send the new setpoint ( $S_{AC}$ ) to the indoor unit.

- After the startup, the value for "external temperature's reference" (register 22/23) has a value -32768 (0x8000). This value means that no external temperature reference is being provided through HS-RC-MBS-1. In this scenario, the setpoint value shown in register 4/5 will always be the same as the current setpoint value of the indoor unit. AC indoor unit will use its own return path temperature sensor as reference for its control loop.
  - When the mechanism of "Virtual Temperature" is applied. The temperature setpoint's value shown by the Remote Controller or other Control System from Hisense connected to the indoor unit may show a different value from the value shown in register 4/5.
  - If it is desired to use the temperature's reading from the Remote Control as the external temperature reference ( $T_{ext}$ , register 22/33), the Remote Controller must be configured as Master, and the Hisense AC indoor unit must have the option "thermostat sensor in the Remote Controller" as activated. This configuration is done via a Hisense Remote Controller connected to the indoor unit and must be done by Hisense authorized installers while the AC is being installed.
  - When HS-RC-MBS-1 is set as "Master" of AB bus, the external temperature's sensor connected to Modbus RTU EIA-485 network provides directly the value currently applied to the indoor unit ( $S_{AC}$ ), and the process of the Virtual temperature is not applied. In this case, the Remote Controller or any other Control System connected from Hisense is not able to send the external temperature reference's value to the register 22/23.
- **AC Real temperature setpoint (R)**  
(register 23 – In Protocol address / register 24 – in PLC address):  
As it has been detailed on the previous point, the real temperature setpoint in the indoor unit and the temperature setpoint requested from HS-RC-MBS-1 might differ (when a value in register 22/23 – "external temperature reference" is entered). This register always informs about the current temperature setpoint which is being used by the indoor unit.

Moreover, notice that temperature's values of all these four registers are expressed according to the temperature's format configured through its onboard DIP-Switches (See "4.3 - DIP-switch Configuration Interface"). These following formats are possible:

- **Celsius value:** Value in Modbus register is the temperature value in Celsius (i.e. a value "22" in the Modbus register must be interpreted as 22°C).
- **Decicelsius value:** Value in Modbus register is the temperature value in decicelsius (i.e. a value "220" in the Modbus register must be interpreted as 22.0°C).
- **Fahrenheit value:** Value in Modbus register is the temperature value in Fahrenheit (i.e. a value "72" in the Modbus register must be interpreted as 72°F (~22°C)).

### 4.3 DIP-switch Configuration Interface

All the configuration values on HS-RC-MBS-1 can be written and read from Modbus interface. Otherwise, some of them can also be setup from its on-board DIP-switch interface. The device has DIP-switches SW1, SW3 and SW4 on the following locations:

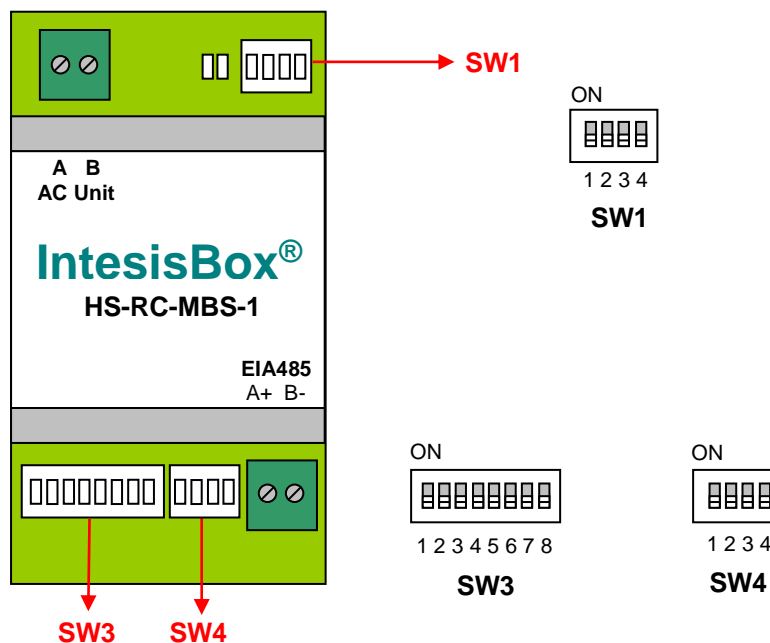















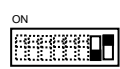

The following tables apply to the interface's configuration through DIP-switches:

#### SW1 – AC indoor unit's features

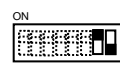
SW1-P1..4	Description
	Slave - A Hisense Remote Controller must be present in AB bus, configured as Master (Default value)
	Master - Hisense Remote Controller not needed in AB bus. If it exists, it must be configured as Slave
	Not used (Default value)
	Not used
	Not used (Default value)
	Not used
	Not used (Default value)
	Not used



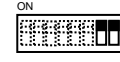



Table 4.1 SW1: AC indoor unit's features

**SW3/SW4** – Baud rate configuration

SW3-P7..8	SW4-P3	Description
		2400bps
		4800bps
		9600bps (Default value)
		19200bps
		38400bps
		57600bps
		76800bps
		115200bps

**Table 4.2** SW3-SW4: Modbus baud rate

**SW4** – Degrees/Decidegrees (x10), temperature magnitude (°C/°F) and EIA-485 termination resistor.

SW4-P1..2-4	Description
	Temperature values in Modbus register are represented in degrees (x1) (Default value)
	Temperature values in Modbus register are represented in decidegrees (x10)
	Temperature values in Modbus register are represented in Celsius degrees (Default value)
	Temperature values in Modbus register are represented in Fahrenheit degrees
	EIA-485 bus without termination resistor (Default value)
	Internal termination resistor of 120Ω connected to EIA-485 bus

**Table 4.3** SW4: Temperature and termination resistor configuration

**SW3** – Modbus Slave address

Add	SW3-P1..6	Add	SW3-P1..6	Add	SW3-P1..6	Add	SW3-P1..6	Add	SW3-P1..6
0		13		26		39		52	
1		14		27		40		53	
2		15		28		41		54	
3		16		29		42		55	
4		17		30		43		56	
5		18		31		44		57	
6		19		32		45		58	
7		20		33		46		59	
8		21		34		47		60	
9		22		35		48		61	
10		23		36		49		62	
11		24		37		50		63	
12		25		38		51			

**Table 4.4** SW3: Modbus slave address

## 4.4 Implemented Functions

HS-RC-MBS-1 implements the following standard Modbus functions:

- 3: Read Holding Registers
- 4: Read Input Registers
- 6: Write Single Register
- 16: Write Multiple Registers (Despite this function is allowed, the interface does not allow to write operations on more than 1 register with the same request, this means that length field should be always be 1 when this function is being used in case of writing)

## 4.5 Device LED indicator

The device includes two LED indicators to show all the possible operational states. In the following table there are written the indicators which can be performed and their meaning.

### L1 (green LED)

Device status	LED indication	ON / OFF Period	Description
During not normal operation	LED blinking	500ms ON / 500ms OFF	Communication error
During normal operation	LED flashing	100ms ON / 1900ms OFF	Normal operation (configured and working properly)

### L2 (red LED)

Device status	LED indication	ON / OFF Period	Description
During not normal operation	LED Pulse	3sec ON / --- OFF	Under voltage

### L1 (green LED) & L2 (red LED)

Device status	LED indication	ON / OFF Period	Description
During normal operation	LED Pulse	5sec ON / --- OFF	Device Start-up
During not normal operation	LED alternatively blinking	500ms ON / 500ms OFF	Flash checksum not OK

## **4.6 EIA-485 bus. Termination resistors and Fail Safe Biasing mechanism**

EIA-485 bus requires a 120Ω terminator resistor at each end of the bus to avoid signal reflections.

In order to prevent fail status detected by the receivers, which are "*listening*" the bus, when all the transmitters' outputs are in three-state (high impedance), it is also required a fail-safe biasing mechanism. This mechanism provides a safe status (a correct voltage level) in the bus when all the transmitters' outputs are in three-state. This mechanism must be supplied by the Modbus Master.

The HS-RC-MBS-1 device includes an on-board terminator resistor of 120Ω that can be connected to the EIA-485 bus by using DIP-switch SW4.

Some Modbus RTU EIA-485 Master devices can provide also internal 120Ω terminator resistor and/or fail safe biasing mechanism (Check the technical documentation of the Master device connected to the EIA-485 network in each case).



## 5. Electrical and Mechanical features

Enclosure	Plastic, type PC (UL 94 V-0) Net dimensions (dxwxh): 93 x 53 x 58 mm / 3.7" x 2.1" x 2.3" Color: Light Grey. RAL 7035	Operation Temperature	0°C to +60°C
Weight	85 g.	Stock Temperature	-20°C to +85°C
Mounting	Wall DIN rail EN60715 TH35.	Operational Humidity	<95% RH, non-condensing
Terminal Wiring (for low-voltage signals)	For terminal: solid wires or stranded wires (twisted or with ferrule) 1 core: 0.5mm <sup>2</sup> ... 2.5mm <sup>2</sup> 2 cores: 0.5mm <sup>2</sup> ... 1.5mm <sup>2</sup> 3 cores: not permitted	Stock Humidity	<95% RH, non-condensing
Modbus RTU port	1 x Serial EIA485 Plug-in screw terminal block (2 poles): A, B Compatible with Modbus RTU EIA-485 networks	Isolation voltage	1500 VDC
AC unit port	1 x AB bus Plug-in screw terminal block (2 poles): A, B Compatible with Hisense networks	Isolation resistance	1000 MΩ
Switch 1 (SW1)	1 x DIP-Switch for AC features	Protection	IP20 (IEC60529)
Switch 3 (SW3)	1 x DIP-Switch for Modbus RTU settings	LED indicators	2 x Onboard LED - Operational status
Switch 4 (SW4)	1 x DIP-Switch for extra functions		

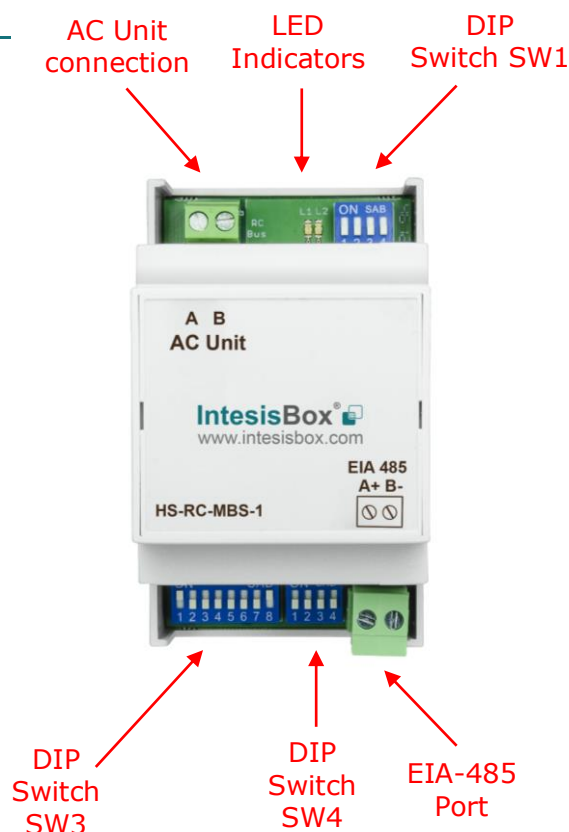
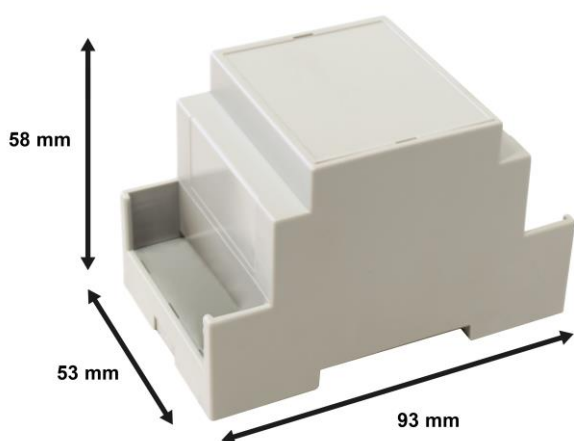

## **6. List of supported AC Unit Types.**

A list of Hisense indoor unit model references compatible with HS-RC-MBS-1 and its available features can be found on this link:

[https://www.intesisbox.com/intesis/support/compatibilities/IntesisBox\\_HS-RC-xxx-1\\_AC\\_Compatibility.pdf](https://www.intesisbox.com/intesis/support/compatibilities/IntesisBox_HS-RC-xxx-1_AC_Compatibility.pdf)

## 7. Error Codes

Error Code Modbus	Error in Remote Controller	Error category	Error Description
0	N/A	HS-RC-MBS-1	No active error
01	01	Indoor Unit	Tripping of Protection Device
02	02	Outdoor Unit	Tripping of Protection Device
03	03	Transmission	Abnormality between Indoor and Outdoor
04	04	Inverter	Abnormality between Inverter and Control PCB
04	04.		
05	05	Transmission	Abnormality of Power Source Wiring
06	06	Voltage drop	Fan motor locked, overload, over current
06	06.		Swing flap motor error
07	07	Cycle	Overcurrent of AC input
08	08		Electronic expansion valve drive error
09	09	Outdoor Unit	Heater overheat
17	11	Sensor on Indoor Unit	Dust collector error / No-maintenance filter error
18	12		Capacity setting error (indoor)
19	13		Shortage of water supply
20	14		Malfunions of a humidifier system (water leaking)
25	19		Malfunions in a sensor system
33	21	Sensor on Outdoor Unit	Sensor system of drain water error
34	22		Heat exchanger (1) (Liquid pipe) thermistor system error
35	23		Heat exchanger (1) (Gas pipe) thermistor system error
36	24		Sensor system error of fan motor locked, overload
41	29		Sensor system of swing flap motor error
48	30		Sensor system of over-current of AC input
49	31		Suction air thermistor error
50	32		Discharge air thermistor system error
53	35		Contamination sensor error
54	36		Humidity sensor error
56	38		Remote control thermistor error
57	39		Radiation sensor error
67	43		Pressure
68	44	Protection devices activated	
69	45	Outdoor unit PCB assembly failure	
70	46	High pressure switch (HPS) activated	
71	47	Low pressure switch (LPS) activated	
81	51	Inverter	Overload of inverter compressor motor
82	52		Over current of STD compressor motor
83	53		Overload of fan motor / Over current of fan motor
84	54		Over current of AC input
86	56	Outdoor Fan	Electronic expansion valve drive error
87	57		Four-way valve error
88	58		Pump motor over current
176	b0	IU model setting	Incorrect setting address or refrigerant cycle
177	b1	Number setting	Incorrect setting address or refrigerant cycle
181	b5		Incorrect setting of indoor unit number for H-LINK type
238	EE	Inverter	Water temperature abnormal
65535 (-1)	N/A	HS-RC-MBS-1	Error in the communication of HS-RC-MBS-1 or the Remote Controller with the AC unit

In case to detect an error code not listed, contact your closest Hitachi technical support service.