

## IBOX-MBS-DALI

### DALI to Modbus Server Protocol Converter

Order Code: IBMBSDAL0640000

#### Installation Sheet rev.1.2

Intesis Software S.L.U. © 2018

## SAFETY INSTRUCTIONS

### WARNING

Follow carefully this safety and installation instructions. Improper work may lead to serious harmful for your health and also may damage seriously the IntesisBox and/or any other equipment connected to it.

IntesisBox must be installed by accredited electrician or similar technical personnel, following all the safety instructions given here and in accordance always with the country legislation for installation of electric equipment.

IntesisBox cannot be installed outdoors or exposed to direct solar radiation, water, high relative humidity or dust.

IntesisBox must only be installed in a restricted access location.

In case of wall mount, fix firmly IntesisBox on a not vibrating surface following the instructions next.

In case of DIN rail mount fix IntesisBox properly to the DIN rail following the instructions below.

Mounting on DIN rail inside a metallic cabinet properly connected to earth is recommended.

Disconnect always power of any wires before manipulating and connecting them to IntesisBox.

A power supply with an NEC Class 2 or Limited Power Source (LPS) and SELV rated is to be used.

Respect always the expected polarity of power and communication cables when connecting them to IntesisBox.

Supply always a correct voltage to power IntesisBox, see details of voltage range admitted by the device in the technical characteristics below.

CAUTION: Risk of Explosion if Battery is replaced by an Incorrect Type. Dispose of Used Batteries according to the instructions. Battery replacement shall be done by an authorized installer.

CAUTION: The device is to be connected only to networks without routing to the outside plant, all communication ports are considered for indoor only.

This device was designed for installation in an enclosure. To avoid electrostatic discharge to the unit in environments with static levels above 4 kV, precautions should be taken when the device is mounted outside an enclosure. When working in an enclosure (ex. making adjustments, setting switches etc.) typical anti-static precautions should be observed before touching the unit.

## CONFIGURATION

Use the **Configuration Tool** to configure the gateway.

See instructions to download and install the latest version at: [http://intesisbox.com/intesis/software/intesisbox\\_maps\\_installer.exe](http://intesisbox.com/intesis/software/intesisbox_maps_installer.exe)

Use the Ethernet connection or the Console Port (mini USB type B connector included) to get communication between the gateway and the configuration tool.

Follow the instructions of the user's manual for more details.

<b>Owner's Record</b>
The model and serial numbers are located on the rear of the gateway. Record these numbers in the space provided below. Refer to them whenever you contact upon your gateway dealer or support team regarding this product.
Model No. _____
Serial No. _____

## INSTALLATION

Follow instructions next to properly install the gateway.

Disconnect from mains the power supply before connecting it to IntesisBox.

Disconnect power of any bus or communication cable before connecting it to IntesisBox.

Mount IntesisBox on the wall or DIN rail following the instruction given below, respecting the safety instructions given above.

Connect a NEC Class 2 or Limited Power Source (LPS) and SELV rated power supply to IntesisBox, respect the polarity if DC power or Line and Neutral if AC power. Apply always a voltage within the range admitted by IntesisBox and of enough power (see technical characteristics).

Circuit-breaker must be used before the power supply. Rating 250V-6A.

Connect the communication cables to IntesisBox, see details on the user's manual.

Power IntesisBox and the rest of devices connected to it.

### Wall Mount

1. Separate the fixing clips in the bottom of the box, pushing them to the outside until hear the "click" which indicates that now the clips are in position for wall mount, see in the figure below.
2. Use the holes of the clips to fix the box in the wall using screws. Use the template below for the wall wholes.

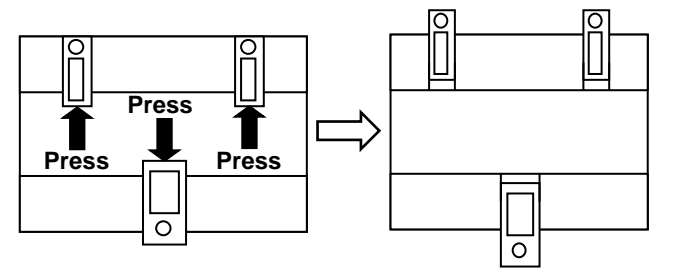

Clips in their original position (for DIN rail mount)      Clips in position for wall mount

### DIN Rail Mount

With the clips of the box in their original position, insert first the box in the upper edge of the DIN rail and later insert the box in the down part of the rail, using a small screwdriver and following the steps in the figure below.

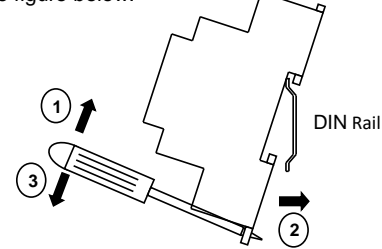

# CONNECTIONS

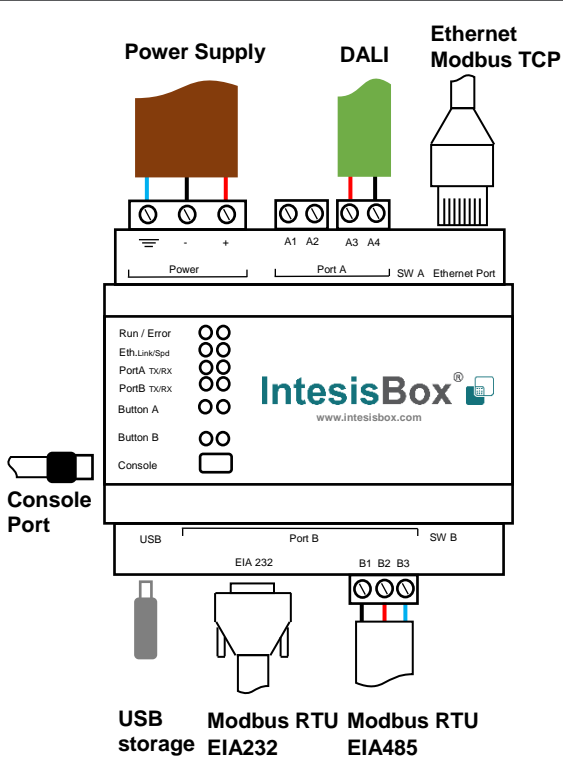

## Power Supply

Must use NEC Class 2 or Limited Power Source (LPS) and SELV rated power supply.

### If using DC power supply:

Respect polarity applied of terminals (+) and (-). Be sure the voltage applied is within the range admitted (check table below). The power supply can be connected to earth but only through the negative terminal, never through the positive terminal.

### If using AC power supply:

Make sure the voltage applied is of the value admitted (24 Vac). Do not connect any of the terminals of the AC power supply to earth, and make sure the same power supply is not supplying any other device.

## Ethernet / Modbus TCP / Console (UDP & TCP)

Connect the cable coming from the IP network to the connector ETH of the gateway. Use an Ethernet CAT5 cable. If communicating through the LAN of the building, contact the network administrator and make sure traffic on the port used is allowed through all the LAN path (check the gateway user manual for more information). DHCP is enabled by default. When disabled, default IP is 192.168.100.246.

## PortA / DALI

Connect the DALI bus to connectors A4 (+), A3 (-) of gateway's PortA. IntesisBox provides 16VDC (+/- 2%) DALI voltage to the bus.

## PortB / Modbus RTU

Connect the EIA485 bus to connectors B1 (-), B2 (+) and B3 (SNGD) of gateway's PortB. Respect the polarity. Remember the characteristics of the standard EIA485 bus: maximum distance of 1200 meters, maximum 32 devices connected to the bus, and in each end of the bus it must be a termination resistor of 120 Ω. The gateway has an internal bus biasing circuit that incorporates the termination resistor. If you install the gateway in one of the ends of the bus, then do not install an additional termination resistor in that end.

Connect the serial cable EIA232 coming from the external serial device to the EIA232 connector of gateway's PortB. This is a DB9 male (DTE) connector in which only the lines TX, RX and GND are used. Details of the pinout can be seen in the user's manual. Respect the maximum distance of 15 meters.

## Console Port

Connect a mini-type B USB cable from your computer to the gateway to allow communication between the Configuration Software and the gateway. Remember that Ethernet connection is also allowed. Check the user manual for more information.

## USB

Connect a USB storage device (not a HDD) if required. Check the user manual for more information.

# ELECTRICAL & MECHANICAL FEATURES

<b>Enclosure</b>	Plastic, type PC (UL 94 V-0) Net dimensions (d×w×h): 90x88x56 mm Recommended space for installation (d×w×h): 130x100x100mm Color: Light Grey. RAL 7035
<b>Mounting</b>	Wall. DIN rail EN60715 TH35.
<b>Terminal Wiring (for power supply and low-voltage signals)</b>	Per terminal: solid wires or stranded wires (twisted or with ferrule) 1 core: 0.5mm <sup>2</sup> ... 2.5mm <sup>2</sup> 2 cores: 0.5mm <sup>2</sup> ... 1.5mm <sup>2</sup> 3 cores: not permitted
<b>Power</b>	1 x Plug-in screw terminal block (3 poles) Positive, Negative, Earth 24VDC
<b>Ethernet</b>	1 x Ethernet 10/100 Mbps RJ45 2 x Ethernet LED: port link and activity
<b>Port A</b>	1 x DALI port (Plug-in screw terminal block orange 2 poles) 1500VDC isolation from other ports DALI power consumption: 240mA Voltage rating: 16VDC 1 x Plug-in screw terminal block green (2 poles) Reserved for future use
<b>Switch A (SWA)</b>	1 x DIP-Switch for PORT A configuration: Reserved for future use
<b>PORT B</b>	1 x Serial EIA232 (SUB-D9 male connector) Modbus RTU 1500VDC isolation from other ports (except PORT B: EIA485) 1 x Serial EIA485 (Plug-in screw terminal block 3 poles) A, B, SNGD (Reference ground or shield) 1500VDC isolation from other ports (except PORT B: EIA485)
<b>Switch B (SWB)</b>	1 x DIP-Switch for serial EIA485 configuration: Position 1: ON: 120 Ω termination active Off: 120 Ω termination inactive Position 2-3: ON: Polarization active Off: Polarization inactive

<b>Battery</b>	Size: Coin 20mm x 3.2mm Capacity: 3V / 225mAh Type: Manganese Dioxide Lithium
<b>Console Port</b>	Mini Type-B USB 2.0 compliant 1500VDC isolation
<b>USB port</b>	Type-A USB 2.0 compliant Only for USB flash storage device (USB pen drive) Power consumption limited to 150mA (HDD connection not allowed)
<b>Push Button</b>	Button A: Check the user manual Button B: Check the user manual
<b>Operation Temperature</b>	0°C to +60°C
<b>Operational Humidity</b>	5 to 95%, no condensation
<b>Protection</b>	IP20 (IEC60529)

<b>LED Indicators</b>	10 x On board LED indicators 2 x Error (red) / Power LED 2 x Ethernet Link / Speed 2 x Port A TX/RX 2 x Port B TX/RX 1 x Button A indicator 1 x Button B indicator
-----------------------	--

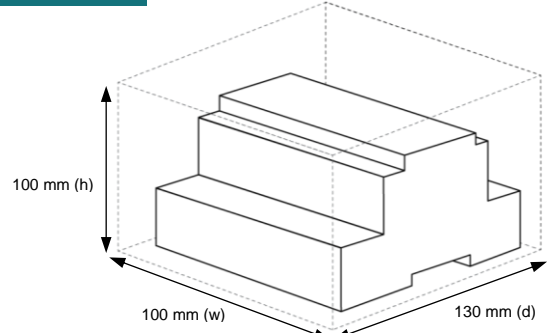

## IBOX-MBS-DALI

### DALI to Modbus Server Protocol Converter

Order Code: IBMBSDAL1280000

#### Installation Sheet rev.1.2

Intesis Software S.L.U. © 2018

## SAFETY INSTRUCTIONS

### WARNING

Follow carefully this safety and installation instructions. Improper work may lead to serious harmful for your health and also may damage seriously the IntesisBox and/or any other equipment connected to it.

IntesisBox must be installed by accredited electrician or similar technical personnel, following all the safety instructions given here and in accordance always with the country legislation for installation of electric equipment.

IntesisBox cannot be installed outdoors or exposed to direct solar radiation, water, high relative humidity or dust.

IntesisBox must only be installed in a restricted access location.

In case of wall mount, fix firmly IntesisBox on a not vibrating surface following the instructions next.

In case of DIN rail mount fix IntesisBox properly to the DIN rail following the instructions below.

Mounting on DIN rail inside a metallic cabinet properly connected to earth is recommended.

Disconnect always power of any wires before manipulating and connecting them to IntesisBox.

A power supply with an NEC Class 2 or Limited Power Source (LPS) and SELV rated is to be used.

Respect always the expected polarity of power and communication cables when connecting them to IntesisBox.

Supply always a correct voltage to power IntesisBox, see details of voltage range admitted by the device in the technical characteristics below.

CAUTION: Risk of Explosion if Battery is replaced by an Incorrect Type. Dispose of Used Batteries according to the instructions. Battery replacement shall be done by an authorized installer.

CAUTION: The device is to be connected only to networks without routing to the outside plant, all communication ports are considered for indoor only.

This device was designed for installation in an enclosure. To avoid electrostatic discharge to the unit in environments with static levels above 4 kV, precautions should be taken when the device is mounted outside an enclosure. When working in an enclosure (ex. making adjustments, setting switches etc.) typical anti-static precautions should be observed before touching the unit.

## CONFIGURATION

Use the **Configuration Tool** to configure the gateway.

See instructions to download and install the latest version at: [http://intesisbox.com/intesis/software/intesisbox\\_maps\\_installer.exe](http://intesisbox.com/intesis/software/intesisbox_maps_installer.exe)

Use the Ethernet connection or the Console Port (mini USB type B connector included) to get communication between the gateway and the configuration tool.

Follow the instructions of the user's manual for more details.

<b>Owner's Record</b> The model and serial numbers are located on the rear of the gateway. Record these numbers in the space provided below. Refer to them whenever you contact upon your gateway dealer or support team regarding this product.  <b>Model No.</b> _____ <b>Serial No.</b> _____
--

## INSTALLATION

Follow instructions next to properly install the gateway.

Disconnect from mains the power supply before connecting it to IntesisBox.

Disconnect power of any bus or communication cable before connecting it to IntesisBox.

Mount IntesisBox on the wall or DIN rail following the instruction given below, respecting the safety instructions given above.

Connect a NEC Class 2 or Limited Power Source (LPS) and SELV rated power supply to IntesisBox, respect the polarity if DC power or Line and Neutral if AC power. Apply always a voltage within the range admitted by IntesisBox and of enough power (see technical characteristics).

Circuit-breaker must be used before the power supply. Rating 250V-6A.

Connect the communication cables to IntesisBox, see details on the user's manual.

Power IntesisBox and the rest of devices connected to it.

### Wall Mount

3. Separate the fixing clips in the bottom of the box, pushing them to the outside until hear the "click" which indicates that now the clips are in position for wall mount, see in the figure below.
4. Use the holes of the clips to fix the box in the wall using screws. Use the template below for the wall wholes.

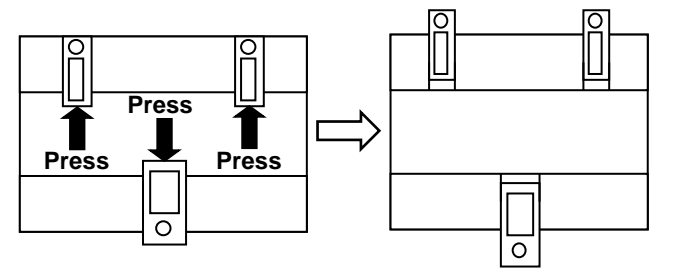

Clips in their original position (for DIN rail mount)      Clips in position for wall mount

### DIN Rail Mount

With the clips of the box in their original position, insert first the box in the upper edge of the DIN rail and later insert the box in the down part of the rail, using a small screwdriver and following the steps in the figure below.

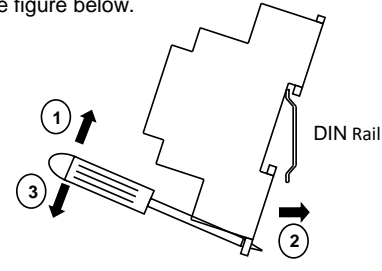

# CONNECTIONS

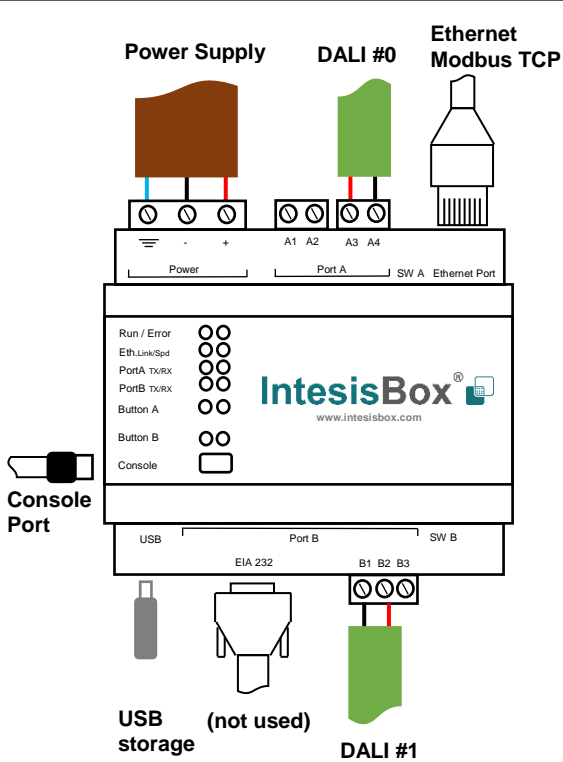

## Power Supply

Must use NEC Class 2 or Limited Power Source (LPS) and SELV rated power supply.

### If using DC power supply:

Respect polarity applied of terminals (+) and (-). Be sure the voltage applied is within the range admitted (check table below). The power supply can be connected to earth but only through the negative terminal, never through the positive terminal.

### If using AC power supply:

Make sure the voltage applied is of the value admitted (24 Vac). Do not connect any of the terminals of the AC power supply to earth, and make sure the same power supply is not supplying any other device.

## Ethernet / Modbus TCP / Console (UDP & TCP)

Connect the cable coming from the IP network to the connector ETH of the gateway. Use an Ethernet CAT5 cable. If communicating through the LAN of the building, contact the network administrator and make sure traffic on the port used is allowed through all the LAN path (check the gateway user manual for more information). DHCP is enabled by default. When disabled, default IP is 192.168.100.246.

## PortA / DALI #0

Connect the DALI bus to connectors A4 (+), A3 (-) of gateway's PortA. IntesisBox provides 16VDC (+/- 2%) DALI voltage to the bus.

## PortB / DALI #1

Connect the DALI bus to connectors B2 (+), B1 (-) of gateway's PortB. IntesisBox provides 16VDC (+/- 2%) DALI voltage to the bus.

## Console Port

Connect a mini-type B USB cable from your computer to the gateway to allow communication between the Configuration Software and the gateway. Remember that Ethernet connection is also allowed. Check the user manual for more information.

## USB

Connect a USB storage device (not a HDD) if required. Check the user manual for more information.

# ELECTRICAL & MECHANICAL FEATURES

<b>Enclosure</b>	Plastic, type PC (UL 94 V-0) Net dimensions (d×w×h): 90x88x56 mm Recommended space for installation (d×w×h): 130x100x100mm Color: Light Grey. RAL 7035
<b>Mounting</b>	Wall. DIN rail EN60715 TH35.
<b>Terminal Wiring (for power supply and low-voltage signals)</b>	Per terminal: solid wires or stranded wires (twisted or with ferrule) 1 core: 0.5mm <sup>2</sup> ... 2.5mm <sup>2</sup> 2 cores: 0.5mm <sup>2</sup> ... 1.5mm <sup>2</sup> 3 cores: not permitted
<b>Power</b>	1 x Plug-in screw terminal block (3 poles) Positive, Negative, Earth 24VDC
<b>Ethernet</b>	1 x Ethernet 10/100 Mbps RJ45 2 x Ethernet LED: port link and activity
<b>Port A</b>	1 x DALI port (Plug-in screw terminal block orange 2 poles) 1500VDC isolation from other ports DALI power consumption: 240mA Voltage rating: 16VDC 1 x Plug-in screw terminal block green (2 poles) Reserved for future use
<b>Switch A (SWA)</b>	1 x DIP-Switch for PORT A configuration: Reserved for future use
<b>PORT B</b>	1 x DALI port (Plug-in screw terminal block green 2 poles) 1500VDC isolation from other ports DALI power consumption: 240mA Voltage rating: 16VDC
<b>Switch B (SWB)</b>	1 x DIP-Switch for PORT B configuration: Reserved for future use

<b>Battery</b>	Size: Coin 20mm x 3.2mm Capacity: 3V / 225mAh Type: Manganese Dioxide Lithium
<b>Console Port</b>	Mini Type-B USB 2.0 compliant 1500VDC isolation
<b>USB port</b>	Type-A USB 2.0 compliant Only for USB flash storage device (USB pen drive) Power consumption limited to 150mA (HDD connection not allowed)
<b>Push Button</b>	Button A: Check the user manual Button B: Check the user manual
<b>Operation Temperature</b>	0°C to +60°C
<b>Operational Humidity</b>	5 to 95%, no condensation
<b>Protection</b>	IP20 (IEC60529)
<b>LED Indicators</b>	10 x On board LED indicators 2 x Error (red) / Power LED 2 x Ethernet Link / Speed 2 x Port A TX/RX 2 x Port B TX/RX 1 x Button A indicator 1 x Button B indicator

