

IntesisBox®

MD-AC-MBS-1/4/8/32 v.1.0

Modbus RTU (EIA-485) Interface for Midea air conditioners.
Compatible with VRF and Commercial lines.

User's Manual

Issue Date: 11/2017
r1.1 EN

References:

- IBMBSMID001I000:** Modbus RTU Interface for 1 Midea indoor unit
- IBMBSMID004I000:** Modbus RTU Interface for 4 Midea indoor units
- IBMBSMID008I000:** Modbus RTU Interface for 8 Midea indoor units
- IBMBSMID0032I000:** Modbus RTU Interface for 32 Midea indoor units

© Intesis Software S.L.U. 2017. All Rights Reserved.

Information in this document is subject to change without notice. No part of this publication may be reproduced, stored in a retrieval system or transmitted in any form or any means electronic or mechanical, including photocopying and recording for any purpose other than the purchaser's personal use without the written permission of Intesis Software S.L.U.

Intesis Software S.L.U.
Milà i Fontanals, 1 bis
08700 Igualada
Spain

TRADEMARKS

All trademarks and tradenames used in this document are acknowledged to be the copyright of their respective holders.

INDEX

1 Presentation 4

2 Connection 5

 2.1 Connect to the AC indoor unit 5

 2.2 Connection to the EIA-485 bus..... 5

 2.3 Connection to the power supply 5

 2.4 Connection diagrams 6

3 Quick Start Guide 7

4 Modbus Interface Specification 8

 4.1 Modbus physical layer 8

 4.2 Modbus Registers for MD-AC-MBS-1 8

 4.2.1 Control and status registers..... 8

 4.2.2 Configuration Registers 10

 4.3 Modbus Registers for MD-AC-MBS-4/8/32..... 11

 4.3.1 Global Control and status registers 11

 4.3.2 Individual Control and status registers 12

 4.3.3 Configuration Registers 13

 4.4 Considerations on Temperature Registers 14

 4.5 DIP-switch Configuration Interface 16

 4.6 Implemented Functions 19

 4.7 Device LED indicator 19

 4.8 EIA-485 bus. Termination resistors and Fail-Safe Biasing mechanism..... 20

5 Electrical and Mechanical features21

6 List of supported AC Unit Types.....22

7 Error Codes23

1 Presentation



The MD-AC-MBS-1/4/8/32 interface allows a complete and natural integration of **Midea** air conditioners into Modbus RTU (EIA-485) networks.

Compatible with VRF and Commercial lines.

Reduced dimensions. 93 x 53 x 58 mm
3.7" x 2.1" x 2.3"

- Quick and easy installation.
Mountable on DIN rail, wall, or even inside the indoor unit on some models of AC.
- External power required.
- Direct connection to Modbus RTU (EIA-485) networks. Up to 63 MD-AC-MBS-4/8/32 devices can be connected on the same network.
MD-AC-MBS-1/4/8/32 is a Modbus slave device.
- Direct connection to the Midea XYE bus.
- Configuration from both on-board DIP-switches and Modbus RTU.
- Total Control and Supervision.
- Real states of the AC unit's internal variables.
- Allows simultaneous use of the AC's remote controls and Modbus RTU.
- Individual control from 1 to 32 AC units with a single interface.

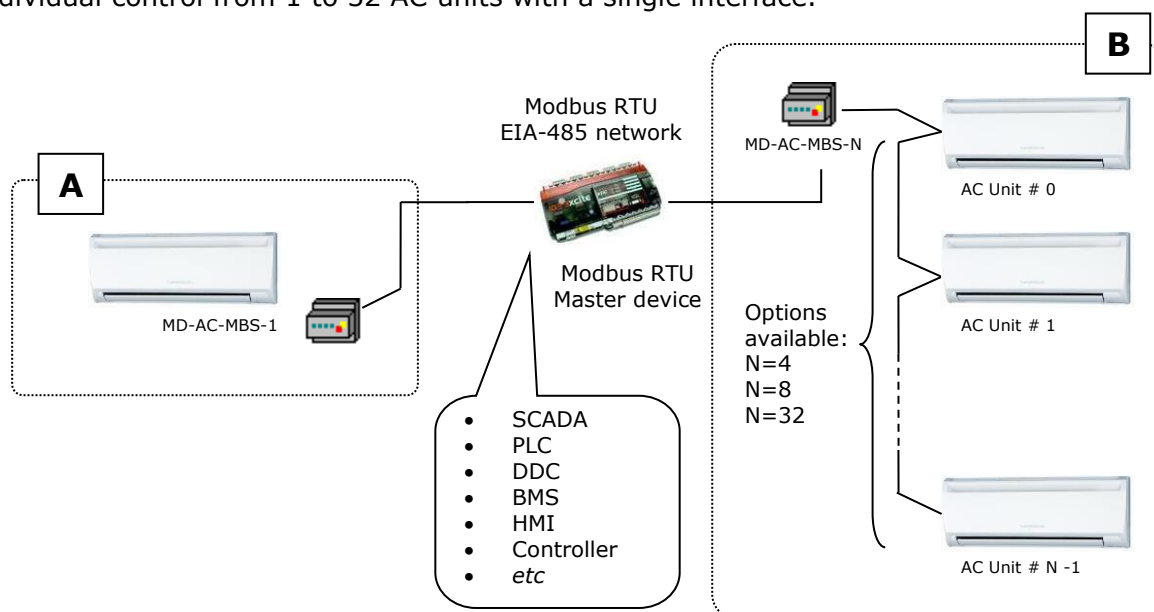

A Integration of single AC unit from independent XYE bus using MD-AC-MBS-1 interface

B Integration of multiple AC units in the same XYE bus using MD-AC-MBS-4/8/32 interface

2 Connection

The interface comes with 3 plug-in terminal blocks of 2 poles.

The first (XY) is used to establish direct connection with the AC indoor unit. The second one (V1V2) is used to provide power.

The third one (AB) is used to establish connection with the Modbus RTU EIA-485 network.

2.1 Connect to the AC indoor unit

The MD-AC-MBS-1/4/8/32 connects directly to the Midea XYE bus. The cable for proper connection is not provided within the interface. Maximum XYE bus length is 100 m (328.08 ft.).

Connector E, from the XYE bus, is not used to connect to the indoor unit or indoor units. The XYE bus has specific polarity.

Depending on the number of AC units to control, the recommended connection' methods can be seen in Figure 2.1 and Figure 2.2.

NOTE: If the CCM central Controller is present in the XYE bus, the MD-AC-MBS-1/4/8/32 can't be connected. Please, disconnect the CCM controller.

2.2 Connection to the EIA-485 bus

Connect the EIA-485 bus wires to the plug-in terminal block (the one of two poles) of the MD-AC-MBS-1/4/8/32 interface and keep the polarity on this connection (A+ and B-).

Make sure that the maximum distance of the bus is 1,200 meters (3,937 ft.). Loop or star typologies are not allowed in the case of the EIA-485. A terminator resistor of 120Ω must be present at each end of the bus to avoid signal reflections. The bus needs a fail-safe biasing mechanism (see section 4.8 for more details).

2.3 Connection to the power supply

The MD-AC-MBS-1/4/8/32 interface needs to be powered from an external power supply.

Use an external 12V DC power supply connected to V1V2 connector. The V1V2 connection has specific polarity (V1- y V2+).

2.4 Connection diagrams

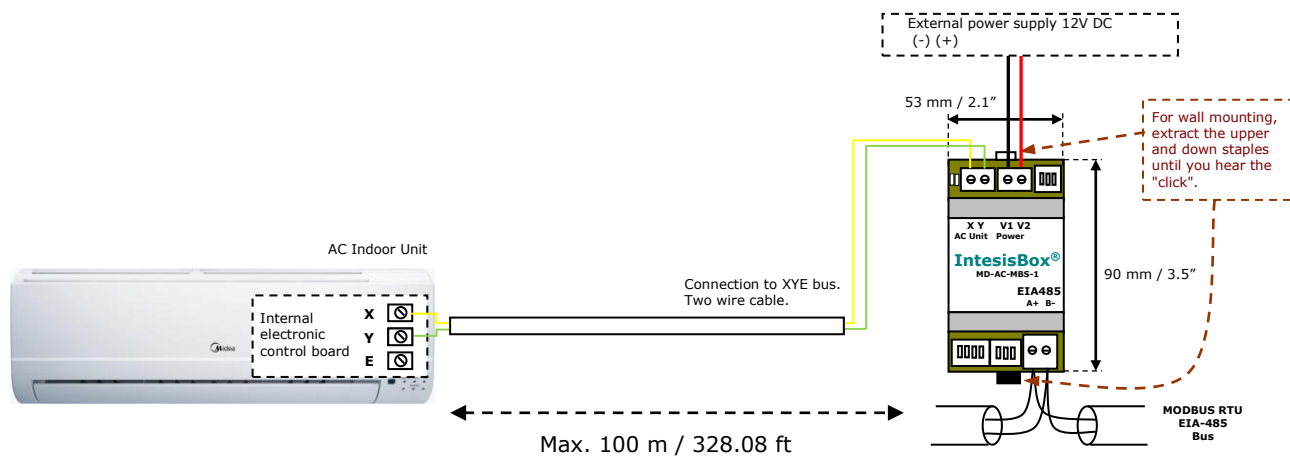

Figure 2.1 MD-AC-MBS-1 connection diagram

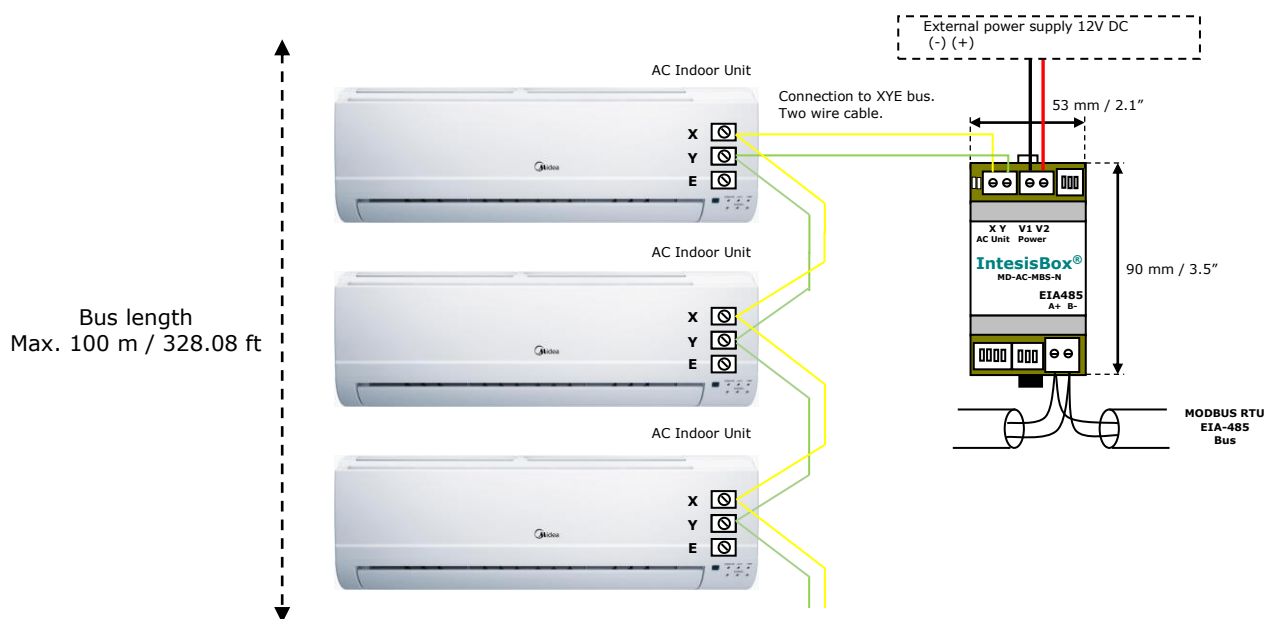

Figure 2.2 MD-AC-MBS-4/8/32 connection diagram

NOTE: If the CCM central Controller is present in the XYE bus, the MD-AC-MBS-1/4/8/32 can't be connected. Please, disconnect the CCM controller.

3 Quick Start Guide

1. Disconnect the air conditioning from the Mains Power.
2. Attach the interface next to the AC indoor unit (wall mounting) following the instructions of the diagram above or install it inside the AC indoor unit (respect the safety instructions provided by the AC manufacturer).
3. Connect the XYE bus between the interface and the AC indoor unit following the instructions of the installation diagram. Screw each bare cable end in the corresponding XY terminals.
4. Connect the EIA-485 bus to the *EIA485* connector of the interface.
5. Connect the power cable between the interface and the Mains Power following the instructions of the diagram. Screw each bare cable end in the corresponding V1 V2 terminals.
6. Close the AC indoor unit.
7. Check the DIP-Switch configuration of the IntesisBox interface and make sure it matches the current installation's parameters:

By default, the interface is set to:

- Modbus Slave Address → 1
- Modbus baud rate → 9600 bps



These parameters can be modified from SW4 and SW3 DIP-Switches.

All other switch positions are set at low level (Off position ) by default.

NOTE: All changes on the DIP-Switch configuration require a system power cycle to be applied.

8. Connect the AC system to Mains Power.

IMPORTANT: The IntesisBox interface requires to be connected to the AC unit (powered) to start the communication.

4 Modbus Interface Specification

4.1 Modbus physical layer

MD-AC-MBS-1/4/8/32 implements a Modbus RTU (Slave) interface, to be connected to an EIA-485 line. It performs an 8N2 communication (8 data bits, no parity and 2 stop bit) with several available baud rates (2400 bps, 4800 bps, 9600 bps -default-, 19200 bps, 38400 bps, 57600 bps, 76800 bps and 115200 bps). It also supports 8N1 communication (8 data bits, no parity and 1 stop bit).

4.2 Modbus Registers for MD-AC-MBS-1

All registers are type "16-bit unsigned Holding Register" and they use the standard *ModBus big endian* notation.

The machine that is being controlled must have Unit Address 0. This address needs to be set in the AC unit.

4.2.1 Control and status registers

Register Address (protocol address)	Register Address (PLC address)	R/W	Description
0	1	R/W	AC unit On/Off <ul style="list-style-type: none"> ▪ 0: Off ▪ 1: On
1	2	R/W	AC unit Mode ¹ <ul style="list-style-type: none"> ▪ 0: Auto (Default value) ▪ 1: Heat ▪ 2: Dry ▪ 3: Fan ▪ 4: Cool
2	3	R/W	AC unit Fan Speed ¹ <ul style="list-style-type: none"> ▪ 0: Auto (Default value) ▪ 1: SP1 ▪ 2: SP2 ▪ 3: SP3
3	4	R/W	AC unit Up/Down Vane Position ¹ <ul style="list-style-type: none"> ▪ 0: Off (Default value) ▪ 10: Swing
4	5	R/W	AC unit Temperature setpoint ^{1,2,3} <ul style="list-style-type: none"> ▪ -32678 (Initialization value) ▪ 17..30 °C (°C/x10°C) ▪ 63..86 °F
5	6	R	AC unit Temperature reference ^{1,2,3} <ul style="list-style-type: none"> ▪ -32678 (Initialization value) ▪ Ranges determined by the Manufacturer of the AC indoor unit. (°C/x10°C/°F)
6	7	R/W	Window Contact <ul style="list-style-type: none"> ▪ 0: Closed (Default Value) ▪ 1: Open

¹ Available values will depend on the AC unit mode. Check the AC unit model functions in its User Manual to know the possible values for this register.

² Magnitude for this register can be adjusted to Celsius x 1°C, Celsius x 10°C (default) or Fahrenheit. See section 4.5 for more information.

³ It is not possible turn to x10 the value shown in Fahrenheit.

Register Address (protocol address)	Register Address (PLC address)	R/W	Description
7	8	R/W	MD-AC-MBS-1 Disablement ⁴ <ul style="list-style-type: none"> 0: MD-AC-MBS-1 enabled (Default) 1: MD-AC-MBS-1 disabled
8	9	R/W	Remote Control Disablement ^{4,5} <ul style="list-style-type: none"> 0: Remote enabled (Default Value) 1: Remote disabled
9	10	R/W	AC unit Operation Time ⁴ <ul style="list-style-type: none"> 0..65535 (hours). Counts the time the AC unit is in "On" state.
10	11	R	AC unit Alarm Status <ul style="list-style-type: none"> 0: No alarm condition 1: Alarm condition
11	12	R	Error Code ⁶ <ul style="list-style-type: none"> 0: No error active 65535 (-1 if it is read as signed value): Error in the communication of MD-AC-MBS-1 with the AC unit Any other error present, see the table at the end of this document.
22	23	R/W	Indoor unit ambient temperature from external sensor (at Modbus side) ⁷ <ul style="list-style-type: none"> -32768: Initial value. No temperature is being provided from an external sensor. Any other: (°C/x10°C/°F)
23	24	R	AC real setpoint temperature ^{1,2,3,7} <ul style="list-style-type: none"> -32678 (Initialization value) 17..30 °C (°C/x10°C) 63..86 °F
66	67	R	Return path Temperature ^{1,2,3} <ul style="list-style-type: none"> -32768 (Initialization value) Ranges determined by the Manufacturer of the AC indoor unit. (°C/x10°C/°F)
97	98	R/W	Block Periodic Sendings ^{4,8,9} <ul style="list-style-type: none"> 0: Non-blocked (Default value) 1: Blocked

⁴ This value is stored in non-volatile memory

⁵ This register blocks the Central panel communication (only if this one has been installed). MD-AC-MBS-1 cannot have installed a Remote Controller at the same time.

⁶ See section 7 for possible error codes and their explanation

⁷ See section 4.8 for more information

⁸ If the register is configured as "0: Non-blocked", all commands received from Modbus will be sent to the AC system. If "1: Blocked", commands from Modbus will only be sent to the AC system if they differ from the previous value (values sent on change).

⁹ This register applies to firmware version 1.0 onwards

4.2.2 Configuration Registers

Register Address (protocol address)	Register Address (PLC address)	R/W	Description
13	14	R/W	"Open Window" switch-off timeout ¹⁰ <ul style="list-style-type: none"> ▪ 0..30 (minutes) ▪ Factory setting: 30 (minutes)
14	15	R	Modbus RTU Baud rate <ul style="list-style-type: none"> ▪ 2400bps ▪ 4800bps ▪ 9600bps (Default Value) ▪ 19200bps ▪ 38400bps ▪ 57600bps ▪ 76800bps ▪ 115200bps
15	16	R	Device's Modbus Slave address <ul style="list-style-type: none"> ▪ 1..63
21	22	R	Max number of fan speeds
49	50	R	Device ID: 0x2200
50	51	R	Software version
99	100	W	Reset/Reboot device <ul style="list-style-type: none"> ▪ 1: Reset
2031	2032	R	Capacity ¹¹ <ul style="list-style-type: none"> ▪ 1: IBMBSMID001I000 (1 Indoor Unit)

¹⁰ Once window contact is open, a count-down to switch off the AC Unit will start from this configured value.

¹¹ The value of this register depends on the N value (being N the number of max. indoor units that admits MD-AC-MBS-1/4/8/32)

4.3 Modbus Registers for MD-AC-MBS-4/8/32

All registers are type "16-bit unsigned Holding Register", and they use the Modbus big endian standard notation.

The machines that are being controlled must be configured starting at Unit Address 0 and finishing at Unit Address N-1 (being N the number of maximum units that can be controlled by the device). These addresses need to be set in the AC unit.

4.3.1 Global Control and status registers

These registers apply to each indoor unit connected to the interface.

Register Address (protocol address)	Register Address (PLC address)	R/W	Description
0	1	W	AC unit On/Off Global <ul style="list-style-type: none"> ▪ 0: Off ▪ 1: On
1	2	W	AC unit Mode Global ¹² <ul style="list-style-type: none"> ▪ 0: Auto ▪ 1: Heat ▪ 2: Dry ▪ 3: Fan ▪ 4: Cool
2	3	W	AC unit Fan Speed Global ¹⁶ <ul style="list-style-type: none"> ▪ 0: Auto ▪ 1: SP1 ▪ 2: SP2 ▪ 3: SP3
3	4	W	AC unit Vane Position Global ¹⁶ <ul style="list-style-type: none"> ▪ 0: Auto/Stop (Default value) ▪ 10: Swing
4	5	W	AC unit Temperature setpoint Global ^{16,13} <ul style="list-style-type: none"> ▪ -32678 (Initialization value) ▪ 17..30 °C (°C/x10°C) ▪ 63..86 °F
8	9	W	Remote lock ^{14,15} <ul style="list-style-type: none"> ▪ 0: Off (Default value) ▪ 1: On

¹² Available values will depend on the AC unit mode. Check the AC unit model functions in its user manual to know the possible values for this register.

¹³ Magnitude for this register can be adjusted to Celsius x 1°C, Celsius x 10°C (default) or Fahrenheit.

¹⁴ This value is stored in a non-volatile memory

¹⁵ This register blocks the Central panel communication (only if this one has been installed). MD-AC-MBS-4/8/32 cannot have installed a Remote Controller at the same time.

4.3.2 Individual Control and status registers

Notice that "n" stands for the Unit Address. These registers apply to each indoor unit connected to the interface.

Register Address (protocol address)	Register Address (PLC address)	R/W	Description
(1000 + 20*n + 0)	(1000 + 20*n + 1)	R/W	AC unit On/Off <ul style="list-style-type: none"> ▪ 0: Off ▪ 1: On
(1000 + 20*n + 1)	(1000 + 20*n + 2)	R/W	AC unit Mode ¹⁶ <ul style="list-style-type: none"> ▪ 0: Auto (Default value) ▪ 1: Heat ▪ 2: Dry ▪ 3: Fan ▪ 4: Cool
(1000 + 20*n + 2)	(1000 + 20*n + 3)	R/W	AC unit Fan Speed ¹⁶ <ul style="list-style-type: none"> ▪ 0: Auto (Default value) ▪ 1: SP1 ▪ 2: SP2 ▪ 3: SP3
(1000 + 20*n + 3)	(1000 + 20*n + 4)	R/W	AC unit Up/Down Vane Position ¹⁶ <ul style="list-style-type: none"> ▪ 0: Off (Default value) ▪ 10: Swing
(1000 + 20*n + 4)	(1000 + 20*n + 5)	R/W	AC unit Temperature setpoint ^{16,17,18} <ul style="list-style-type: none"> ▪ -32678 (Initialization value) ▪ 17..30 °C (°C/x10°C) ▪ 63..86 °F
(1000 + 20*n + 5)	(1000 + 20*n + 6)	R	AC unit Temperature reference ^{16,17,18} <ul style="list-style-type: none"> ▪ -32678 (Initialization value) ▪ Ranges determined by the Manufacturer of the AC indoor unit. (°C/x10°C/°F)
(1000 + 20*n + 6)	(1000 + 20*n + 7)	R	AC Alarm status <ul style="list-style-type: none"> ▪ 0: No Alarm ▪ 1: Alarm
(1000 + 20*n + 7)	(1000 + 20*n + 8)	R	AC Error Code ¹⁹ <ul style="list-style-type: none"> ▪ 0: No error active ▪ 65535 (-1 if it is read as signed value). Error in the communication of MD-AC-MBS-4/8/32 with the AC unit ▪ Any other error present, see the table at the end of this document.
(1000 + 20*n + 8)	(1000 + 20*n + 9)	R/W	Remote lock ^{20,21} <ul style="list-style-type: none"> ▪ 0: Off (Default value) ▪ 1: On

¹⁶ Available values will depend on the AC unit mode. Check the AC unit model functions in its user manual to know the possible values for this register.

¹⁷ Magnitude for this register can be adjusted to Celsius x 1°C, Celsius x 10°C (default) or Fahrenheit.

¹⁸ It is not possible turn to x10 the value shown in Fahrenheit.

¹⁹ See section 7 for possible error codes and their explanation.

²⁰ This value is stored in a non-volatile memory

²¹ This register blocks the Central panel communication (only if this one has been installed). MD-AC-MBS-4/8/32 cannot have installed a Remote Controller at the same time.

4.3.3 Configuration Registers

Register Address (protocol address)	Register Address (PLC address)	R/W	Description
2000	2001	R	Device ID: 0x2200
2031	2032	R	Capacity ²² <ul style="list-style-type: none"> ▪ 4: IBMBSMID004I000 (4 Indoor Units) ▪ 8: IBMBSMID008I000 (8 Indoor Units) ▪ 32: IBMBSMID0032I000 (32 Indoor Units)
2040	2041	R	Modbus RTU Baud rate <ul style="list-style-type: none"> ▪ 2400bps ▪ 4800bps ▪ 9600bps (Default) ▪ 19200bps ▪ 38400bps ▪ 57600bps ▪ 76800bps ▪ 115200bps
2041	2042	R	Device's Modbus Slave address <ul style="list-style-type: none"> ▪ 1..63
2050	2051	R	Software version
2099	2100	W	Reset/Reboot device <ul style="list-style-type: none"> ▪ 1: Reset

²² The value of this register depends on the N value (being N the number of max. indoor units that admits MD-AC-MBS-4/8/32)

4.4 Considerations on Temperature Registers

The next information refers to MD-AC-MBS-1 and may not apply to MD-AC-MBS-4/8/32.

- **AC unit temperature setpoint (R/W)**

(register 4 – in Protocol address / register 5 – in PLC address):

This is the adjustable temperature setpoint value that must be required by the user.

This register can be read (Modbus function 3 or 4) or written (Modbus functions 6 or 16). A remote controller connected to the Midea indoor unit will report the same temperature setpoint value as this register, but only will happen when no AC unit's external reference is provided from MD-AC-MBS-1 (see detail for register 22/23 below).

- **AC unit temperature reference (R)**

This register reports the temperature that is currently used by the Midea indoor unit as the reference of its own control loop. Depending on the configuration of the indoor unit, this value can be the temperature reported by the sensor on the return path of the Midea indoor unit or the sensor of its remote controller. It is a read-only register (Modbus functions 3 or 4).

- **AC unit external temperature reference (R/W)**

(register 22 – in Protocol address / register 23 – in PLC address):

This register allows us to provide an external temperature's sensor from the Modbus side. Midea indoor unit does not allow on devices like MD-AC-MBS-1 to provide directly temperature to be used as a reference of the control loop of the AC indoor unit. In order to overcome this limitation and enable the usage of an external temperature sensor (i.e. from Modbus side), MD-AC-MBS-1 applies the following mechanism (only if "external temperature's reference" is being used):

- After a couple of values have been entered in the "AC unit external temperature's reference" (register 22/23) and "AC unit temperature set point" (register 4/5), MD-AC-MBS-1 is going to estimate the temperature chosen implied (e.g. if a "temperature setpoint (register 4/5)" of **22°C**, and an "external temperature reference (register 22/23)" of **20°C** are entered, MD-AC-MBS-1 will assume that the user is demanding a **+2°C** increase in temperature).
- By knowing at any time the ambient temperature currently used by the indoor unit to control its own operation (register 5/6), MD-AC-MBS-1 can calculate the required temperature setpoint needed to apply the decrease/increase on the real temperature and reach the temperature chosen by the user (following the example above, if MD-AC-MBS-1 reads an "ambient temperature" (register 5/6) of **24°C** in the indoor unit, it will apply a final setpoint of **24°C + 2°C = 26°C**).
- At this moment, each time that MD-AC-MBS-1 detects a change on the ambient temperature reported by the indoor unit (register 5/6), it will also change the required setpoint, in order to keep the temperature required by the user at any time. If we follow the last example, if MD-AC-MBS-1 receives a new temperature's value coming from the indoor unit of **25°C**, MD-AC-MBS-1 will automatically adjust the temperature setpoint required of the AC indoor unit to **25°C + 2°C = 27°C**).

- In general, MD-AC-MBS-1 is constantly applying the "Virtual Temperature" formula:

$$S_{AC} = S_u - (T_u - T_{AC})$$

Where:

- S_{AC} - setpoint value currently applied to the indoor unit
- S_u - setpoint value written at Modbus side (register 4/5)
- T_u - external temperature reference written at Modbus side (register 22/23)
- T_{AC} - ambient temperature that the indoor unit is using as the reference of its own control loop (register 5/6)

When MD-AC-MBS-1 detects a change in any of the values of $\{S_u, T_u, T_{AC}\}$, it will send the new setpoint (S_{AC}) to the indoor unit.

- After the startup, the value for "external temperature's reference" (register 22/23) has a value -32768 (0x8000). This value means that no external temperature reference is being provided through MD-AC-MBS-1. In this scenario, the setpoint value shown in register 4/5 will always be the same as the current setpoint value of the indoor unit. AC indoor unit will use its own return path temperature sensor as reference for its control loop.
 - When the mechanism of "Virtual Temperature" is applied. The temperature setpoint's value shown by the Remote Controller from Midea connected to the indoor unit may show a different value from the value shown in register 4/5.
- **Current setpoint in AC indoor unit (R)**

(register 23 – In Protocol address / register 24 – in PLC address):

As it has been detailed on the previous point, the real temperature setpoint in the indoor unit and the temperature setpoint requested from MD-AC-MBS-1 might differ (when a value in register 22/23 – "external temperature reference" is entered). This register always informs about the current temperature setpoint which is being used by the indoor unit – it also includes the temperature setpoint that will be shown by an additional remote controller from Midea connected to the indoor unit, if it is present on the system.

Moreover, notice that temperature's values of all these three registers are expressed according to the temperature's format configured through its onboard DIP-Switches. The following formats are possible:

- **Celsius value:** Value in Modbus register is the temperature value in Celsius (i.e. a value "22" in the Modbus register must be interpreted as 22°C).
- **Decicelsius value:** Value in Modbus register is the temperature value in decicelsius (i.e. a value "220" in the Modbus register must be interpreted as 22.0°C).
- **Fahrenheit value:** Value in Modbus register is the temperature value in Fahrenheit (i.e. a value "72" in the Modbus register must be interpreted as 72°F (~22°C)).

4.5 DIP-switch Configuration Interface

All the configuration values on MD-AC-MBS-1/4/8/32 can be written and read from Modbus interface. Otherwise, some of them can also be setup from its on-board DIP-switch interface. The device has DIP-switches SW1, SW3 and SW4 on the following locations:

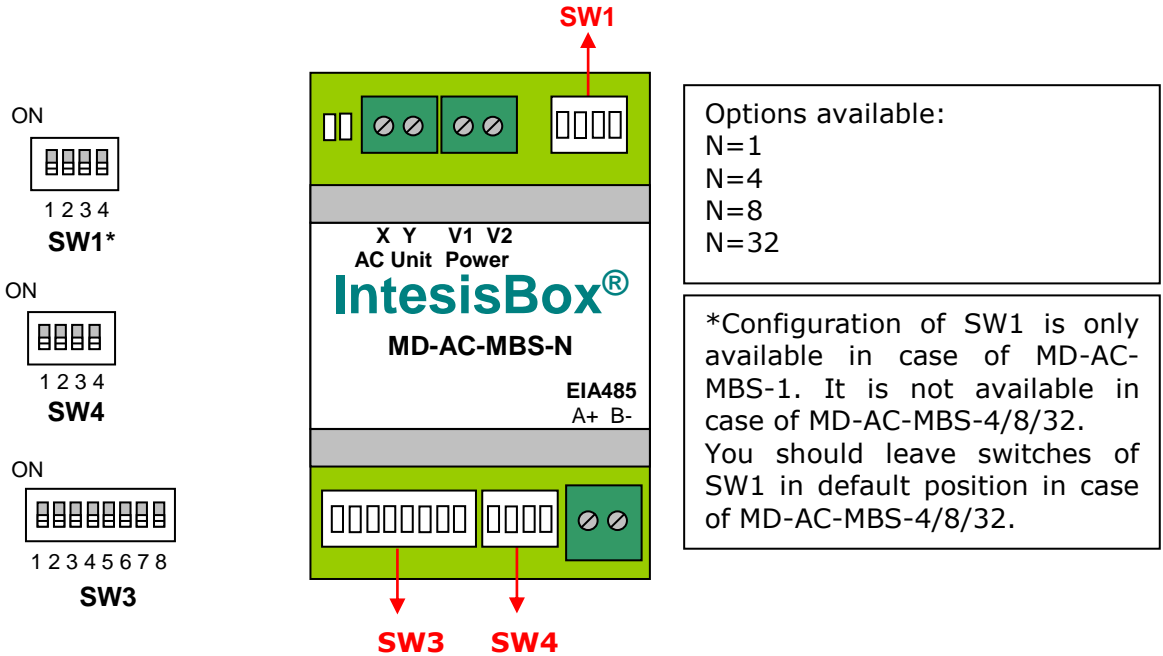

The following tables apply to the interface's configuration through DIP-switches:

SW1 – AC indoor unit's features

SW1-P1..4	Description
	AC Unit does not have AUTO mode (Default value)
	AC Unit has AUTO mode
	AC Unit does not have DRY mode (Default value)
	AC Unit has DRY mode
	AC Unit does not have fan AUTO mode (Default value)
	AC Unit has fan AUTO mode
	AC Unit has 2 fan speeds (Default value)
	AC Unit has 3 fan speeds

Table 4.1 SW1: AC indoor unit's features

SW3/SW4 – Baud rate configuration















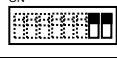

SW3-P7..8	SW4-P3	Description
		2400bps
		4800bps
		9600bps (Default value)
		19200bps
		38400bps
		57600bps
		76800bps
		115200bps

Table 4.2 SW3-SW4: Modbus baud rate

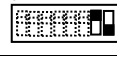
SW4 – Degrees/Decidegrees (x10), temperature magnitude (°C/°F) and EIA-485 termination resistor.

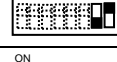





SW4-P1..2-4	Description
	Temperature values in Modbus register are represented in degrees (x1) (Default value)
	Temperature values in Modbus register are represented in decidegrees (x10)
	Temperature values in Modbus register are represented in Celsius degrees (Default value)
	Temperature values in Modbus register are represented in Fahrenheit degrees
	EIA-485 bus without termination resistor (Default value)
	Internal termination resistor of 120Ω connected to EIA-485 bus

Table 4.3 SW4: Temperature and termination resistor configuration

SW3 – Modbus Slave address

Add	SW3-P1..6	Add	SW3-P1..6	Add	SW3-P1..6	Add	SW3-P1..6	Add	SW3-P1..6
0		13		26		39		52	
1		14		27		40		53	
2		15		28		41		54	
3		16		29		42		55	
4		17		30		43		56	
5		18		31		44		57	
6		19		32		45		58	
7		20		33		46		59	
8		21		34		47		60	
9		22		35		48		61	
10		23		36		49		62	
11		24		37		50		63	
12		25		38		51			

Table 4.4 SW3: Modbus Slave address

4.6 Implemented Functions

MD-AC-MBS-1/4/8/32 implements the following standard Modbus functions:

- 3: Read Holding Registers
- 4: Read Input Registers
- 6: Write Single Register
- 16: Write Multiple Registers (Despite this function is allowed, the interface does not allow to write operations on more than 1 register with the same request, this means that length field should always be 1 when this function is being used in case of writing)

4.7 Device LED indicator

The device includes a LED indicator to show all the possible operational states. In the following table there are written the indicators which can be performed and its meaning.

L1 (green LED)

Device status	LED indication	ON / OFF Period	Description
During not normal operation	LED blinking	500ms ON / 500ms OFF	Communication error
During normal operation	LED flashing	100ms ON / 1900ms OFF	Normal operation (configured and working properly)

L2 (red LED)

Device status	LED indication	ON / OFF Period	Description
During not normal operation	LED Pulse	3sec ON / --- OFF	Under voltage

L1 (green LED) & L2 (red LED)

Device status	LED indication	ON / OFF Period	Description
During normal operation	LED Pulse	5sec ON / --- OFF	Device Start-up
During not normal operation	LED alternatively blinking	500ms ON / 500ms OFF	Flash checksum not OK

4.8 EIA-485 bus. Termination resistors and Fail-Safe Biasing mechanism

EIA-485 bus requires a 120Ω terminator resistor at each end of the bus to avoid signal reflections.

In order to prevent fail status detections by the receivers, which are "listening" the bus, when all the transmitters' outputs are in three-state (high impedance), it is also required a fail-safe biasing mechanism. This mechanism provides a safe status (a correct voltage level) in the bus when all the transmitters' outputs are in three-state.

The MD-AC-MBS-1/4/8/32 device includes an on-board terminator resistor of 120Ω that can be connected to the EIA-485 bus by using DIP-switch SW4.

Some Modbus RTU EIA-485 Master devices can provide also internal 120Ω terminator resistor and/or fail-safe biasing. Check the technical documentation of the Master device connected to the EIA-485 network in each case.

5 Electrical and Mechanical features

Enclosure	Plastic, type PC (UL 94 V-0) Net dimensions (dxwxh): 93 x 53 x 58 mm / 3.7" x 2.1" x 2.3" Color: Light Grey. RAL 7035	Operation Temperature	0°C to +60°C
Weight	85 g.	Stock Temperature	-20°C to +85°C
Mounting	Wall DIN rail EN60715 TH35.	Operational Humidity	<95% RH, non-condensing
Terminal Wiring (for low-voltage signals)	For terminal: solid wires or stranded wires (twisted or with ferrule) 1 core: 0.5mm ² ... 2.5mm ² 2 cores: 0.5mm ² ... 1.5mm ² 3 cores: not permitted	Stock Humidity	<95% RH, non-condensing
Modbus RTU port	1 x Serial EIA485 Plug-in screw terminal block (2 poles) A, B Compatible with Modbus RTU EIA-485 networks	Isolation voltage	1500 VDC
AC unit port	1 x XYE bus Plug-in screw terminal block (2 poles): X, Y Compatible with Midea XYE bus	Isolation resistance	1000 MΩ
Power port	1 x V1 V2 Power screw terminal block (2 poles): V1, V2		
Switch 1 (SW1)	1 x DIP-Switch for AC features	Protection	IP20 (IEC60529)
Switch 3 (SW3)	1 x DIP-Switch for Modbus RTU settings	LED indicators	2 x Onboard LED - Operational status
Switch 4 (SW4)	1 x DIP-Switch for extra functions		

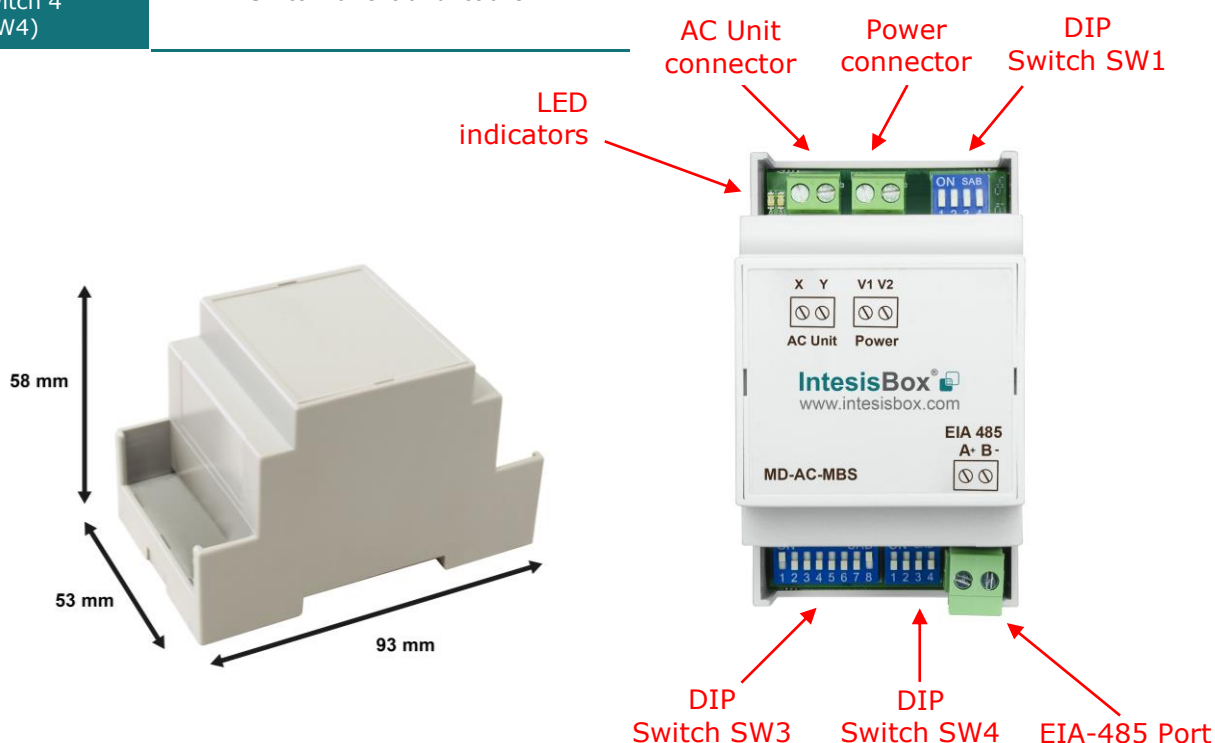

6 List of supported AC Unit Types

A list of Midea indoor unit model 's references compatible with MD-AC-MBS-1/4/8/32 and its available features can be found in:

https://www.intesisbox.com/intesis/support/compatibilities/IntesisBox_MD-AC-xxx-yy_AC_Compatibility.pdf

7 Error Codes

Error Code	Error in Remote Controller	Error description
0	N/A	No active error
1	E0	Phase error or error in the phase sequence
2	E1	Communication error
3	E2	T1 sensor error
4	E3	T2A sensor error
5	E4	T2B sensor error
6	E5	T3 temperature and T4 temperature Compressor discharge temperature sensors error
7	E6	Zero cross error detection
8	E7	EEPROM memory error
9	E8	Indoor fan speed out of control
10	E9	Communication error between the main panel and the visualization panel
11	EA	Compressor's current overload error (4 times)
12	EB	Inverter module protection
13	EC	Cooling error
14	ED	Outdoor unit fault protection
15	EE	Water level fault detection
16	EF	Other errors
101	P0	Vaporizer temperature protection
102	P1	Thawing or cold air protection
103	P2	Condenser high temperatures protection
104	P3	Compressor temperature protection
105	P4	Evacuation duct temperature protection
106	P5	Discharge high pressure protection
107	P6	Discharge low pressure protection
108	P7	Current overload or under load protection
109	P8	Compressor's current overload protection
110	P9	Reserved
111	PA	Reserved
112	PB	Reserved
113	PC	Reserved
114	PD	Reserved
115	PE	Reserved
116	PF	Other protection measures
65535 (-1)	N/A	Error in the communication of MD-AC-MBS-1/4/8/32 with the AC unit
-100	N/A	License error / Indoor units not supported by current license
-200	N/A	Overconsumption error in EXY bus

In case you detect an error code not listed, contact your nearest Midea technical support service.