



PA-RC2-MBS-1

Modbus RTU (EIA-485) Interface for Panasonic and Sanyo air conditioners. Compatible with ECOi and PACi line models.

User Manual

Issue Date: 12/2018
r2.4 EN

Order Codes:

PA-RC2-MBS-1: Modbus RTU Interface for Panasonic and Sanyo air conditioners

© Intesis Software S.L.U. 2018. All Rights Reserved.

Information in this document is subject to change without notice. No part of this publication may be reproduced, stored in a retrieval system or transmitted in any form or any means electronic or mechanical, including photocopying and recording for any purpose other than the purchaser's personal use without the written permission of Intesis Software S.L.U.

Intesis Software S.L.U.
Milà i Fontanals, 1 bis
08700 Igualada
Spain

TRADEMARKS

All trademarks and tradenames used in this document are acknowledged to be the copyright of their respective holders.

INDEX

1. Presentation.....4

2. Connection5

 2.1 Connect to the AC indoor unit5

 2.2 Connection to the EIA-485 bus6

3. Quick Start Guide6

4. Modbus Interface Specification.....7

 4.1 Modbus physical layer7

 4.2 Modbus Registers.....7

 4.2.1 Control and status registers7

 4.2.2 Configuration Registers..... 10

 4.2.3 Considerations on Temperature Registers..... 11

 4.2.4 Special behavior – Outdoor demand rate..... 12

 4.3 DIP-switch Configuration Interface 13

 4.4 Implemented Functions 16

 4.5 Device LED indicator 16

 4.6 EIA-485 bus. Termination resistors and Fail-Safe Biasing mechanism 17

5. Mechanical and electrical features 18

6. List of supported AC Unit Types. 19

7. Error Codes.....20

1. Presentation



The PA-RC2-MBS-1 interfaces allow a complete and natural integration of **Panasonic** and **Sanyo** air conditioners into Modbus RTU (EIA-485) networks.

Compatible with all models of ECOi and PACi line

Reduced dimensions. 93 x 53 x 58 mm
3.7" x 2.1" x 2.3"

- Quick and easy installation.
Mountable on DIN rail, wall, or even inside the indoor unit of AC.
- External power not required.
- Direct connection to Modbus RTU (EIA-485) networks. Up to 63 PA-RC2-MBS-1 devices can be connected in the same network.
PA-RC2-MBS-1 is a Modbus slave device.
- Direct connection to the AC indoor unit. Up to 16 AC indoor units can be connected to PA-RC2-MBS-1, controlling them as one (not individually).
- Configuration from both on-board DIP-switches and Modbus RTU.
- Total Control and Supervision.
- Real states of the AC unit's internal variables.
- Allows simultaneous use of the AC's remote controls and Modbus RTU.

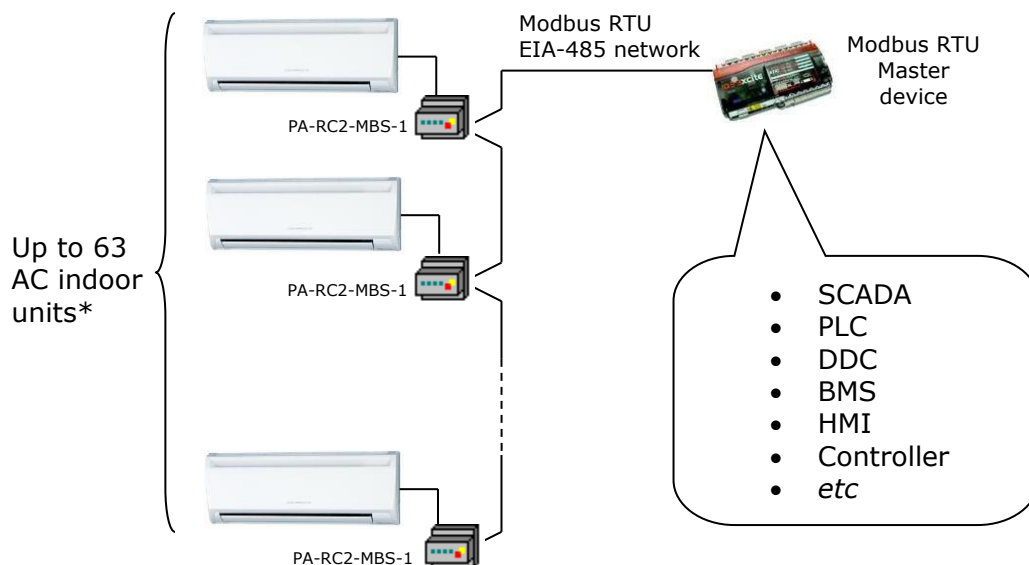

* Up to 63 IntesisBox devices can be installed in the same Modbus RTU bus. However, depending on the configured speed, the installation of Modbus Repeaters may be required

2. Connection

The interface comes with a plug-in terminal block of 2 poles to establish direct connection with the AC indoor unit. It comes as well with a plug-in terminal block of 2 poles to establish direct connection with the Modbus RTU EIA-485 network.

2.1 Connect to the AC indoor unit

The PA-RC2-MBS-1 connects directly to the Panasonic R1R2 Bus, which is not provided within the interface. The recommended connection methods are the following ones (details in Figure 2.1):

- **Wired remote control available. It is not recommended to install more than 1 Remote Controller in the bus R1R2.**
- **No remote control available**

Maximum R1R2 bus length is 500 meters / 1,640.42 ft. The bus has no polarity sensitivity.

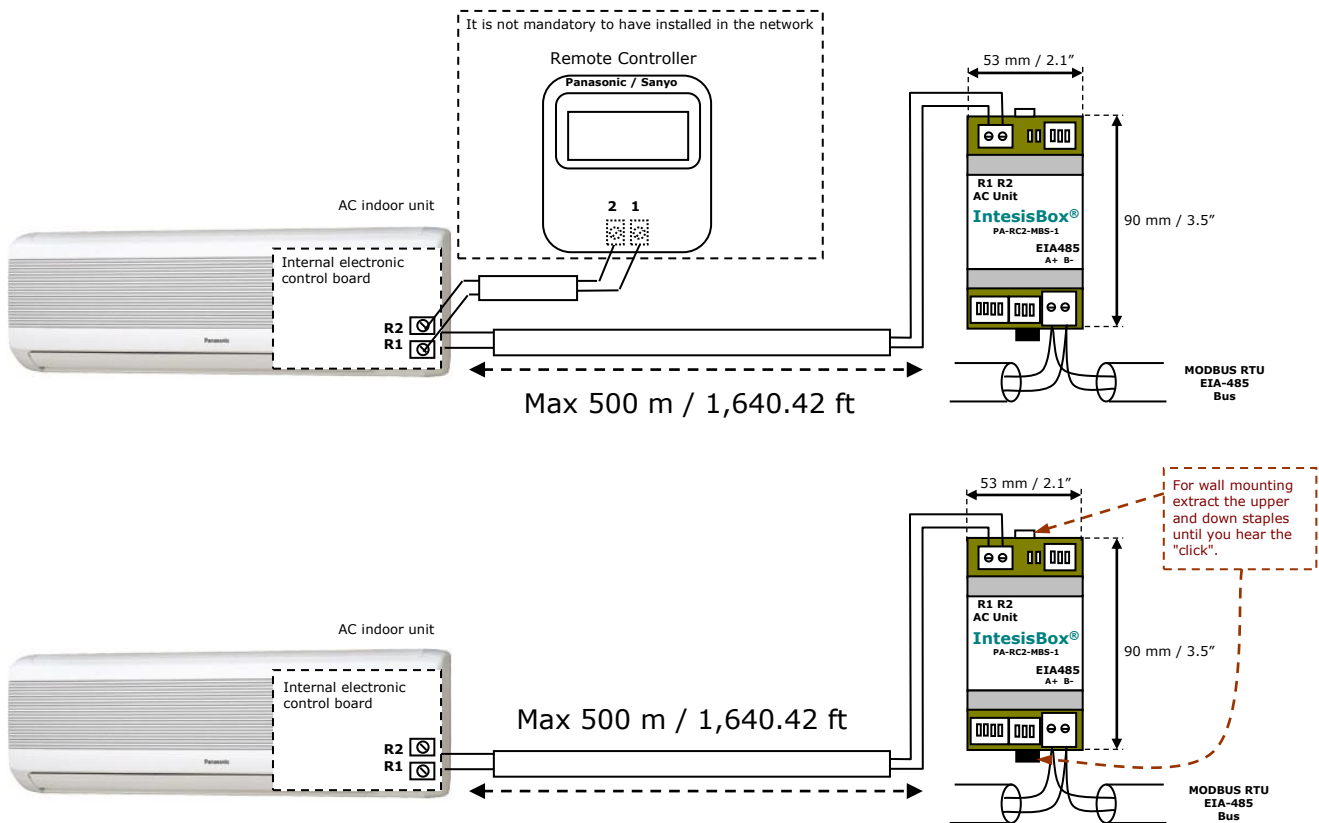

Figure 2.1 PA-RC2-MBS-1 connection diagram

2.2 Connection to the EIA-485 bus

Connect the EIA-485 bus wires to the plug-in terminal block of PA-RC2-MBS-1 and keep the polarity on this connection (A+ and B-). Make sure that the maximum distance to the bus is 1,200 meters (3,937 ft). Loop or star typologies are not allowed in the case of the EIA-485 bus. A terminator resistor of 120Ω must be present at each end of the bus to avoid signal reflections. The bus needs a fail-safe biasing mechanism (see section 4.6 for more details).

3. Quick Start Guide

1. Disconnect the air conditioning from the Mains Power.
2. Attach the interface next to the AC indoor unit (wall mounting) following the instructions of the diagram below or install it inside the AC indoor unit (respect the safety instructions given).
3. Connect the R1R2 bus between the interface and the AC indoor unit following the instructions of the diagram. Screw each bare cable end in the corresponding R1R2 terminals of each device.
4. Connect the EIA-485 bus to the connector *EIA485* of the interface.
5. Close the AC indoor unit.
6. Check the DIP-Switch configuration of the IntesisBox interface and make sure it matches the current installation's parameters:

By default, the interface is set to:

- Modbus Slave Address → 1
- Modbus baud rate → 9600 bps



These parameters can be modified from SW4 and SW3 DIP-Switches.

All other switch positions are set at low level (Off position ) by default.

NOTE: All changes on the DIP-Switch configuration require a system power cycle to be applied.

7. Connect the AC system to Mains Power.

IMPORTANT: The IntesisBox interface requires to be connected to the AC unit (powered) to start communicating.

4. Modbus Interface Specification

4.1 Modbus physical layer

PA-RC2-MBS-1 implements a Modbus RTU (Slave) interface, to be connected to an EIA-485 line. It performs 8N2 communication (8 data bits, no parity and 2 stop bit) with several available baud rates (2400 bps, 4800 bps, 9600 bps -default-, 19200 bps, 38400 bps, 57600 bps, 76800 bps and 115200 bps). It also supports 8N1 communication (8 data bits, no parity and 1 stop bit).

4.2 Modbus Registers

All registers are type "16-bit unsigned Holding Register" and they use the *Modbus big endian* notation.

4.2.1 Control and status registers

Register Address (protocol address)	Register Address (PLC address)	R/W	Description
0	1	R/W	AC unit On/Off <ul style="list-style-type: none"> ▪ 0: Off ▪ 1: On
1	2	R/W	AC unit Mode ¹ <ul style="list-style-type: none"> ▪ 0: Auto ▪ 1: Heat ▪ 2: Dry ▪ 3: Fan ▪ 4: Cool
2	3	R/W	AC unit Fan Speed ¹ <ul style="list-style-type: none"> ▪ 0: Auto ▪ 1: Low ▪ 2: Mid ▪ 3: High
3	4	R/W	AC unit Vane Position ¹ <ul style="list-style-type: none"> ▪ 0: Auto ▪ 1: POS1 (Horizontal) ▪ 2: POS2 (Horizontal) ▪ 3: POS3 (Med) ▪ 4: POS4 (Vert) ▪ 5: POS5 (Vert) ▪ 10: Swing
4	5	R/W	AC unit Temperature Setpoint ^{1,2,3} <ul style="list-style-type: none"> ▪ -32768 (Initialization value) ▪ 16..32°C (°C/x10°C) ▪ 61..90°F

¹ Available values will depend on the AC unit mode. Check the AC unit model functions in its user manual to know the possible values for this register.

² Magnitude for this register can be adjusted to Celsius x 10°C, Celsius x 10°C (default) or Fahrenheit. See section 0 for more information.

³ It is not possible turn to x10 the value shown in Fahrenheit.

Register Address (protocol address)	Register Address (PLC address)	R/W	Description
5	6	R/W	AC unit Temperature reference ^{1,2,3,4} <ul style="list-style-type: none"> -32768: Initialization value. Value invalid, which comes from the IU's sensor. If the value that is shown in register 22 (23 PLC) is valid, the address is going to take this value. Ranges are specific from Manufacturer (°C/x10°C/°F)
6	7	R/W	Window Contact <ul style="list-style-type: none"> 0: Closed (Default) 1: Open
7	8	R/W	PA-RC2-MBS-1 Disablement ⁵ <ul style="list-style-type: none"> 0: PA-RC2-MBS-1 enabled (Default) 1: PA-RC2-MBS-1 disabled
8	9	R/W	AC Remote Control Disablement ⁵ <ul style="list-style-type: none"> 0: Remote Control enabled (Default) 1: Remote Control disabled
9	10	R/W	AC unit Operation Time ⁵ <ul style="list-style-type: none"> 0..65535 (hours). Counts the time the AC unit is in "On" state.
10	11	R	AC unit Alarm Status <ul style="list-style-type: none"> 0: No alarm condition 1: Alarm condition
11	12	R	Error Code ⁶ <ul style="list-style-type: none"> 0: No Error active 65535 (-1): Error in the communication of PA-RC2-MBS-1 with the AC unit Any other error present, see the table at the end of this document.
22	23	R/W	Indoor unit's ambient temperature from external sensor (at Modbus side) ^{4,7} <ul style="list-style-type: none"> -32768: Initialization value. No temperature is being provided from an input sensor. There's no input sensor. Other: (°C/x10°C/°F)
23	24	R	AC setpoint temperature ^{1,2,3,4,7} <ul style="list-style-type: none"> When no external temperature is provided, this read-only register will have the same value as register 5 (PLC addressing). In all cases, it will show the current setpoint in the indoor unit. Ranges specific from Manufacturer (°C/x10°C/°F)
24	25	R	Current AC max setpoint ^{1,2,3,4} <ul style="list-style-type: none"> -32768 (Initialization value) Ranges are specific from Manufacturer (°C/x10°C/°F)
25	26	R	Current AC min setpoint ^{1,2,3,4} <ul style="list-style-type: none"> -32768 (Initialization value) Ranges are specific from Manufacturer (°C/x10°C/°F)

⁴ The temperature's value shown has decimal precision(x0,5°C)

⁵ This value is stored in non-volatile memory

⁶ See section 7 for possible error codes and their explanation

⁷ See section 4.2.3 for more information

Register Address (protocol address)	Register Address (PLC address)	R/W	Description
31	32	R	Status (feedback) <ul style="list-style-type: none"> 0: Not active (Default value) 1: Active (A window is open)
37	38	R	Auto Mode <ul style="list-style-type: none"> 0: Auto 1: Heat 2: Dry 3: Fan 4: Cool
40	41	R	Window contact ON/OFF Disablement <ul style="list-style-type: none"> 0: Window contact is not disabling option On/Off at this moment (Default value) 1: Window contact is disabling option On/Off at this moment
44	45	R	Filter status <ul style="list-style-type: none"> 0: Off (Default value) 1: Lit
65	66	R	Input reference temp. (feedback) ^{1,2,3,4} <ul style="list-style-type: none"> -32768 (Initialization value) Any: (°C/x10°C/°F)
66	67	R	Return Path temperature ^{1,2,3,4} <ul style="list-style-type: none"> -32768 (Initialization value) Any: (°C/x10°C/°F)
97	98	R/W	Block Periodic Sendings ^{5,8,9} <ul style="list-style-type: none"> 0: Non-blocked (Default value) 1: Blocked
4001	4002	R	Indoor Unit Master Force Thermo Off ¹⁰ <ul style="list-style-type: none"> 0: No Limit 1: Thermo Forced Off
4002	4003	R	Indoor Unit Master Error Code ¹⁰ <ul style="list-style-type: none"> 0: No Error active 65535 (-1): Communication Error Any other error present, check the Manual of the Indoor Unit.
4003	4004	R	Indoor Unit Master Setpoint Temp. ^{1,2,3,4,10} <ul style="list-style-type: none"> -32768 (Initialization value) Any: (°C/x10°C/°F)
4004	4005	R	Indoor Unit Master Room Temp. ^{1,2,3,10} <ul style="list-style-type: none"> -32768 (Initialization value) Any: (°C/x10°C/°F)
4011	4012	R	Indoor Unit Slave Force Thermo Off ¹⁰ <ul style="list-style-type: none"> 0: No Limit 1: Thermo Forced Off
4012	4013	R	Indoor Unit Slave Error Code ¹⁰ <ul style="list-style-type: none"> 0: No Error active 65535 (-1): Communication Error Any other error present, check the Manual of the Indoor Unit.

⁸ If the register is configured as "0:Non-blocked", all commands received from Modbus will be sent to the AC system. If "1: Blocked", commands from Modbus will only be sent to the AC system if they differ from the previous value.

⁹ This register applies on firmware version 2.3 onwards

¹⁰ Check Section 4.2.4 to know more about the applications of Master/Slave on indoor units.

Register Address (protocol address)	Register Address (PLC address)	R/W	Description
4013	4014	R	Indoor Unit Slave Setpoint Temp. ^{1,2,3,4,10} <ul style="list-style-type: none"> -32768 (Initialization value) Any: (°C/x10°C/°F)
4014	4015	R	Indoor Unit Slave Room Temp. ^{1,2,3,4,10} <ul style="list-style-type: none"> -32768 (Initialization value) Any: (°C/x10°C/°F)

4.2.2 Configuration Registers

Register Address (protocol address)	Register Address (PLC address)	R/W	Description
13	14	R/W	"Open Window" switch-off timeout ¹¹ <ul style="list-style-type: none"> 0..30 (minutes) Factory setting: 30 (minutes)
14	15	R	Modbus RTU baud-rate <ul style="list-style-type: none"> 2400bps 4800bps 9600bps (Default value) 19200bps 38400bps 57600bps 76800bps 115200bps
15	16	R	Modbus Slave Address <ul style="list-style-type: none"> 1..63
21	22	R	Max number of fan speeds
43	44	W	Filter reset <ul style="list-style-type: none"> 1: Reset
48	49	R	Switch value
49	50	R	Device ID: 0x1500
50	51	R	Software version
67	68	R	Number of Indoor Units connected
81	82	R	Error address <ul style="list-style-type: none"> Provides the indoor unit's number which is showing the error
82	83	R/W	Outdoor Demand Rate DV <ul style="list-style-type: none"> 0x00: Thermo Off 0xFF: No limit (Normal operation) 40..150: Operating range of the equipment (Current's magnitude (A))
83	84	R	Outdoor Demand Rate Max Value ¹²
84	85	R	Outdoor Demand Rate Min Value ¹²
99	100	W	Reset <ul style="list-style-type: none"> 1: Reset
4000	4001	R	Indoor Unit Master Address ¹⁰
4010	4011	R	Indoor Unit Slave Address ¹⁰

¹¹ Once window contact is open, a count-down to switch off the AC Unit will start from this configured value.

¹² This value is shown as portions of 100%. Check the explanation in Section 4.2.4 of this document

4.2.3 Considerations on Temperature Registers

- **AC unit temperature setpoint (R/W)**

(register 4 – in Protocol address / register 5 – in PLC address):

This is the adjustable temperature setpoint value that must be required by the user.

This register can be read (Modbus function 3 or 4) or written (Modbus functions 6 or 16).

A remote controller connected to the Panasonic/Sanyo indoor unit will report the same temperature setpoint value as this register.

- **AC unit temperature reference (R)**

(register 5 – in Protocol address / register 6 – in PLC address):

This register reports the temperature that is currently used by the Panasonic/Sanyo indoor unit as the reference of its own control loop.

If the value on the register 22 is valid (different from 0x8000), it will report the value from this register. If not, it will show the indoor unit reference's temperature.

It is a read-only register (Modbus functions 3 or 4).

- **AC unit external temperature reference (R/W)**

(register 22 – in Protocol address / register 23 – in PLC address):

This register reports the temperature from an external sensor in the Modbus side. If valid value is received, the Modbus register will indicate a 0x8000 value.

This register can be read (Modbus function 3 or 4) or written (Modbus functions 6 or 16).

- **Current setpoint in AC indoor unit (R)**

(register 23 – In Protocol address / register 24 – in PLC address):

This register will show the same value as in register 4 (protocol address). The reference temperature from the remote controller is sent directly to the AC unit to be applied in the control loop.

It is a read-only register (Modbus functions 3 or 4).

Moreover, notice that temperature's values of all these four registers are expressed according to the temperature's format configured through its onboard DIP-Switches (See Section 4.3) These following formats are possible:

- **Celsius value:** Value in Modbus register is the temperature value in Celsius (i.e. a value "22" in the Modbus register must be interpreted as 22°C).
- **Decicelsius value:** Value in Modbus register is the temperature value in decicelsius (i.e. a value "220" in the Modbus register must be interpreted as 22.0°C).
- **Fahrenheit value:** Value in Modbus register is the temperature value in Fahrenheit (i.e. a value "72" in the Modbus register must be interpreted as 72°F (~22°C)).

4.2.4 Special behavior – Outdoor demand rate

This feature is related to a kind of control that allows to obtain a more accurate feedback of supply air's temperature based on the current system's performance and condition. It is as well a feature related to the integration in the smart building control's system with the gateway. (For example, in case that it could exist already some smart electric price's schedules, when the electricity's price varies during all day).

The feature of the Outdoor demand rate is related as well to the feature Master/Slave of the AC system from Panasonic/Sanyo.

The roles Master/Slave of the indoor units are related to the features Back Up and Rotation Function. To apply these functions properly, two independent indoor units (each one belongs to a different AC system) must be connected together (in pairs) and name one indoor unit as Master and the other one as Slave.

Once each indoor unit had been named, it's necessary to verify that each one of the two indoor units match with the Modbus registers properly. The registers with Master category belong to the indoor unit named as Master and the registers with Slave category belong to the indoor unit named as Slave.

The three registers related to the Outdoor Demand Rate can be read and written. These ones are configurable thanks to a Remote Controller from Panasonic/Sanyo with Back Up and Rotation Function.

4.3 DIP-switch Configuration Interface

All the configuration values on PA-RC2-MBS-1 can be written and read from Modbus interface. Otherwise, some of them can also be setup from its on-board DIP-switch interface. The device has DIP-switches SW1, SW3 and SW4 on the following locations:

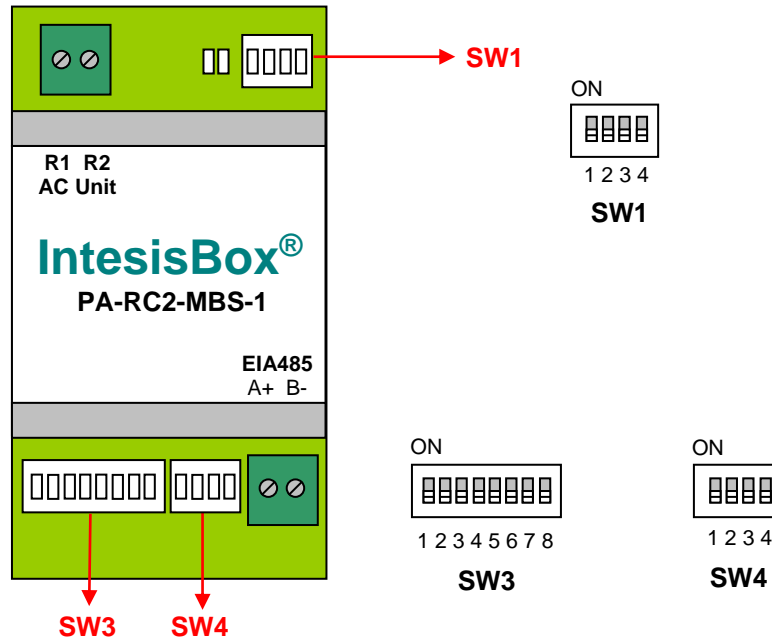

The following tables apply to the interface's configuration through DIP-switches:

SW1 – AC indoor unit's features

SW1-P1..4	Description
	Outdoor Demand rate not activated (Default value)
	Outdoor Demand rate activated
	Not used (Default value)
	Not used
	Not used (Default value)
	Not used
	Not used (Default value)
	Not used

Table 4.1 SW1: AC indoor unit's features

SW3/SW4 – Baud rate configuration















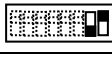

SW3-P7..8	SW4-P3	Description
		2400bps
		4800bps
		9600bps (Default value)
		19200bps
		38400bps
		57600bps
		76800bps
		115200bps

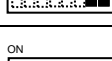
Table 4.2 SW3-SW4: Modbus baud rate

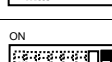
SW4 – Degrees/Decidegrees (x10), temperature magnitude (°C/°F) and EIA-485 termination resistor.

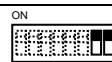





SW4-P1..2-4	Description
	Temperature values in Modbus register are represented in degrees (x1) (Default value)
	Temperature values in Modbus register are represented in decidegrees (x10)
	Temperature values in Modbus register are represented in Celsius degrees (Default value)
	Temperature values in Modbus register are represented in Fahrenheit degrees
	EIA-485 bus without termination resistor (Default value)
	Internal termination resistor of 120Ω connected to EIA-485 bus

Table 4.3 SW4: Temperature and termination resistor configuration

SW3 – Modbus Slave address

Add	SW3-P1..6	Add	SW3-P1..6	Add	SW3-P1..6	Add	SW3-P1..6	Add	SW3-P1..6
0		13		26		39		52	
1		14		27		40		53	
2		15		28		41		54	
3		16		29		42		55	
4		17		30		43		56	
5		18		31		44		57	
6		19		32		45		58	
7		20		33		46		59	
8		21		34		47		60	
9		22		35		48		61	
10		23		36		49		62	
11		24		37		50		63	
12		25		38		51			

Table 4.4 SW3: Modbus slave address

4.4 Implemented Functions

PA-RC2-MBS-1 implements the following standard Modbus functions:

- 3: Read Holding Registers
- 4: Read Input Registers
- 6: Write Single Register
- 16: Write Multiple Registers (Despite this function is allowed, the interface does not allow to write operations on more than 1 register with the same request, this means that length field should be always be 1 when this function is being used in case of writing)

4.5 Device LED indicator

The device includes two LED indicators to show all the possible operational states. In the following table there are written the indicators which can be performed and their meaning.

L1 (green LED)

Device status	LED indication	ON / OFF Period	Description
During not normal operation	LED blinking	500ms ON / 500ms OFF	Communication error
During normal operation	LED flashing	100ms ON / 1900ms OFF	Normal operation (configured and working properly)

L2 (red LED)

Device status	LED indication	ON / OFF Period	Description
During not normal operation	LED Pulse	3sec ON / --- OFF	Under voltage

L1 (green LED) & L2 (red LED)

Device status	LED indication	ON / OFF Period	Description
During normal operation	LED Pulse	5sec ON / --- OFF	Device Start-up
During not normal operation	LED alternatively blinking	500ms ON / 500ms OFF	EEPROM failure

4.6 EIA-485 bus. Termination resistors and Fail-Safe Biasing mechanism

EIA-485 bus requires a 120Ω terminator resistor at each end of the bus to avoid signal reflections.

In order to prevent fail status detected by the receivers, which are "*listening*" the bus, when all the transmitters' outputs are in three-state (high impedance), it is also required a fail-safe biasing mechanism. This mechanism provides a safe status (a correct voltage level) in the bus when all the transmitters' outputs are in three-state. This mechanism must be supplied by the Modbus Master.

The PA-RC2-MBS-1 device includes an on-board terminator resistor of 120Ω that can be connected to the EIA-485 bus by using DIP-switch SW4.

Some Modbus RTU EIA-485 Master devices can provide also internal 120Ω terminator resistor and/or fail-safe biasing mechanism (Check the technical documentation of the Master device connected to the EIA-485 network in each case).

5. Mechanical and electrical features

Enclosure	Plastic, type PC (UL 94 V-0) Net dimensions (dxwxh): 93 x 53 x 58 mm / 3.7" x 2.1" x 2.3" Color: Light Grey. RAL 7035	Operation Temperature	0°C to +60°C
Weight	85 g.	Stock Temperature	-20°C to +85°C
Mounting	Wall DIN rail EN60715 TH35.	Operational Humidity	<95% RH, non-condensing
Terminal Wiring (for low-voltage signals)	For terminal: solid wires or stranded wires (twisted or with ferrule) 1 core: 0.5mm ² ... 2.5mm ² 2 cores: 0.5mm ² ... 1.5mm ² 3 cores: not permitted	Stock Humidity	<95% RH, non-condensing
Modbus RTU port	1 x Serial EIA485 Plug-in screw terminal block (2 poles): A, B Compatible with Modbus RTU EIA-485 networks	Isolation voltage	1500 VDC
AC unit port	1 x R1R2 bus Plug-in screw terminal block (2 poles): R1, R2 Compatible with Panasonic/Sanyo networks	Isolation resistance	1000 MΩ
Switch 1 (SW1)	1 x DIP-Switch for AC features	Protection	IP20 (IEC60529)
Switch 3 (SW3)	1 x DIP-Switch for Modbus RTU settings	LED indicators	2 x Onboard LED - Operational status
Switch 4 (SW4)	1 x DIP-Switch for extra functions		

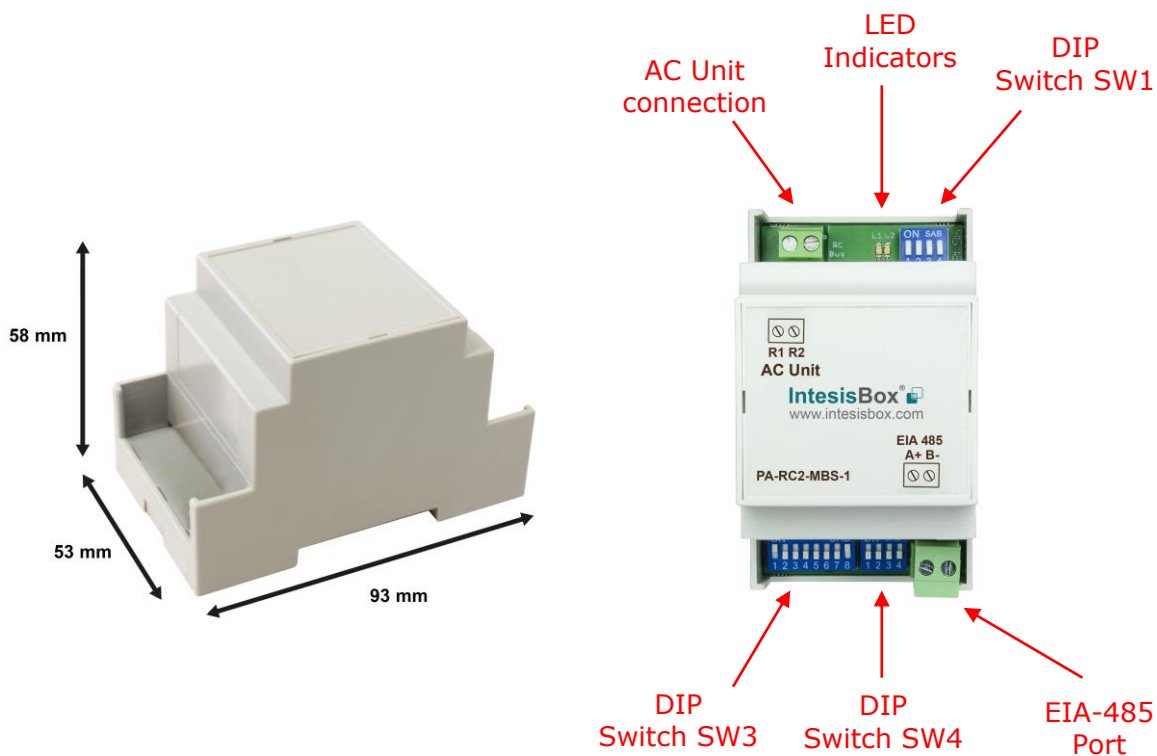

6. List of supported AC Unit Types.

A list of Panasonic and Sanyo indoor unit model references compatible with PA-RC2-MBS-1 and their available features can be found in:

Panasonic:

https://www.intesisbox.com/intesis/support/compatibilities/IntesisBox_PA-RC2-xxx-1_Panasonic_Compatibility.pdf

Sanyo:

https://www.intesisbox.com/intesis/support/compatibilities/IntesisBox_PA-RC2-xxx-1_Sanyo_Compatibility.pdf

7. Error Codes

Error Code Modbus	Error in Remote Controller	Error category	Error Description
0	N/A	PA-RC2-MBS-1	No active error
01	A01	GHP Engine Issues	GHP - Engine oil pressure fault
02	A02		GHP - Engine oil level fault
03	A03		GHP - Engine over speed
04	A04		GHP - Engine under speed
05	A05		GHP - Ignition power supply failure
06	A06		GHP - Engine start up failure
07	A07		GHP - Fuel gas valve failure
08	A08		GHP - Engine stalled
09	A09		GHP - Engine overload
0A	A10		GHP - High exhaust gas temp
0B	A11		GHP - Engine oil level failure
0C	A12		GHP - Throttle actuator fault
0D	A13		GHP - Fuel gas valve adjustment failure
0E	A14		GHP - Engine oil pressure sensor fault
0F	A15		GHP - Starter power output short circuit
10	A16		GHP - Starter motor locked
11	A17		GHP - Starter current (CT) coil failed
13	A19		GHP - Wax Valve (3 Way) fault
14	A20		GHP - Cooling water temp high
15	A21		GHP - Cooling water level fault
16	A22		GHP - Cooling water pump fault
17	A23		GHP - Engine crank angle sensor failure
18	A24		GHP - Engine cam angle sensor failure
19	A25		GHP - Clutch fault
1A	A26		GHP - Misfire
1B	A27		GHP - Catalyst temperature fault
1C	A28		GHP - Generator fault
1D	A29		GHP - Converter fault
1E	A30		GHP - Fuel gas pressure low
21	C01		Central Controller Issues
22	C02	Central control number of units mis-matched	
23	C03	Incorrect wiring of central control	
24	C04	Incorrect connection of central control	
25	C05	System Controller fault, error in transmitting comms signal, i/door or o/door unit not working, wiring fault	
26	C06	System Controller fault, error in receiving comms signal, i/door or o/door unit not working, wiring fault, CN1 not connected correctly	
2C	C12	Batch alarm by local controller	
30	C16	Transmission error from adaptor to unit	
31	C17	Reception error to adaptor from unit	
32	C18	Duplicate central address in adaptor	
33	C19	Duplicate adaptor address	
34	C20	Mix of PAC & GHP type units on adaptor	
35	C21	Memory fault in adaptor	
36	C22	Incorrect address setting in adaptor	
37	C23	Host terminal software failure	
38	C24	Host terminal hardware failure	
39	C25	Host terminal processing failure	
3A	C26	Host terminal communication failure	

3C	C28		Reception error of S-DDC from host terminal	
3D	C29		Initialization failure of S-DDC	
3F	C31		Configuration change detected by adaptor	
41	E01	Addressing and Communication Problems	Remote control detecting error from indoor unit, Address not set/Auto address failed. Check interconnecting wiring etc. Re-address system.	
42	E02		Remote detecting error from indoor unit,	
43	E03		Indoor unit detecting error from remote,	
44	E04		Indoor seeing error from outdoor. Qty of i/d units connected are less than qty set. Check; all i/d units are ON, reset turn off all units wait 5min power up	
45	E05		Indoor unit detecting error from outdoor unit, Error in sending comms signal	
46	E06		Outdoor unit detecting error from indoor unit, Error in receiving comms signal	
47	E07		Outdoor unit detecting error from indoor unit, Error in sending comms signal	
48	E08		Incorrect setting indoor/controller, Indoor address duplicated	
49	E09		Incorrect setting indoor/controller, Remote address duplicated or IR wireless controller not disabled	
4A	E10		Indoor unit detecting error from 'option' plug, Error in sending comms signal	
4B	E11		Indoor unit detecting error from 'option' plug, Error in receiving comms signal	
4C	E12		Auto addressing failed, Auto address connector CN100 shorted during auto addressing	
4D	E13		Indoor unit failed to send signal to remote controller	
4E	E14		Setting Failure, Duplication of master indoor units	
4F	E15		Auto addressing failed, Number of indoor units connected are less than number set	
50	E16		Auto addressing failed, Number of indoor units connected are more than number set	
51	E17		Group control wiring error, Main indoor unit not sending signal for sub indoor units	
52	E18		Group control wiring error, Main indoor unit not receiving signal for sub indoor units	
54	E20		Auto addressing failed, No indoor units connected	
58	E24		Auto addressing failed, Error on sub outdoor unit	
59	E25		Auto addressing failed, Error on outdoor unit address setting	
5A	E26		Auto addressing failed, Quantity of main and sub outdoor units do not correspond to the number set on main outdoor unit P.C.B.	
5D	E29		Auto addressing failed, Sub outdoor unit not receiving comms for main outdoor unit	
5F	E31		Between units, Comms failure with MDC, does E31 remain after power is re-instated? If so replace PCB. & power PCB	
61	F01		Sensor Faults	Indoor Heat Exchanger inlet temp sensor failure (E1)
62	F02			Indoor Heat Exchanger freeze temp sensor failure (E2)
63	F03	Indoor Heat Exchanger outlet temp sensor failure (E3)		
64	F04	Outdoor Discharge temp sensor failure (TD) or (DISCH1)		
65	F05	Outdoor Discharge temp sensor failure (DISCH2)		
66	F06	Outdoor Heat Exchanger temp sensor failure (C1) or (EXG1)		
67	F07	Outdoor Heat Exchanger temp sensor failure (C2) or (EXL1)		
68	F08	Outdoor Air temp sensor failure (TO)		
6A	F10	Indoor inlet temp sensor failure		

6B	F11	Sensor Faults	Indoor outlet temp sensor failure	
6C	F12		Outdoor Intake sensor failure (TS)	
6D	F13		GHP - Cooling water temperature sensor failure	
70	F16		Outdoor High pressure sensor failure	
71	F17		GHP - Cooling water temperature sensor fault	
72	F18		GHP - Exhaust gas temperature sensor fault	
74	F20		GHP Clutch coil temperature fault	
77	F23		Outdoor Heat Exchanger temp sensor failure (EXG2)	
78	F24		Outdoor Heat Exchanger temp sensor failure (EXL2)	
7D	F29		Indoor EEPROM error	
7E	F30		Clock Function (RTC) fault	
7F	F31		Outdoor EEPROM error	
81	H01		Compressor Issues	Compressor Fault, Over current (Comp1)
82	H02			Compressor Fault, Locked rota current detected (Comp1)
83	H03	Compressor Fault, No current detected (Comp1)		
85	H05	Compressor Fault, Discharge temp not detected (Comp1)		
86	H06	Compressor Fault, Low Pressure trip		
87	H07	Compressor Fault, Low oil level		
88	H08	Compressor Fault, Oil sensor Fault (Comp1)		
8B	H11	Compressor Fault, Over current (Comp2)		
8C	H12	Compressor Fault, Locked rota current detected (Comp2)		
8D	H13	Compressor Fault, No current detected (Comp2)		
8F	H15	Compressor Fault, Discharge temp not detected (Comp2)		
95	H21	Compressor Fault, Over current (Comp3)		
96	H22	Compressor Fault, Locked rota current detected (Comp3)		
97	H23	Compressor Fault, No current detected (Comp3)		
99	H25	Compressor Fault, Discharge temp not detected (Comp3)		
9B	H27	Compressor Fault, Oil sensor fault (Comp2)		
9C	H28	Compressor Fault. Oil sensor (connection failure)		
9F	H31	Compressor Fault. IPM trip (IMP current on temperature)		
C1	L01	Incorrect Settings		Setting Error, Indoor unit group setting error
C2	L02			Setting Error, Indoor/outdoor unit type/model mismatched
C3	L03		Duplication of main indoor unit address in group control	
C4	L04		Duplication of outdoor unit system address	
C5	L05		2 or more controllers have been set as 'priority' in one system - shown on controllers set as 'priority'	
C6	L06		2 or more controllers have been set as 'priority' in one system - shown on controllers not set as 'priority'	
C7	L07		Group wiring connected on and individual indoor unit	
C8	L08		Indoor unit address/group not set	
C9	L09		Indoor unit capacity code not set	
CA	L10		Outdoor unit capacity code not set	
CB	L11		Group control wiring incorrect	
CD	L13		Indoor unit type setting error, capacity	
CF	L15		Indoor unit paring fault	
D0	L16		Water heat exchanger unit setting failure	
D1	L17		Miss-match of outdoor unit with different refrigerant	
D2	L18		4-way valve failure	
D3	L19		Water heat exchanger unit duplicated address	
D5	L21		Gas type setup failure	
E1	P01		Indoor Unit	Indoor unit fault, Fan motor thermal overload
E2	P02			Outdoor unit fault, Compressor motor thermal overload, over or under voltage
E3	P03	Outdoor unit fault, Compressor discharge temperature too high (Comp1) over 111 °C. Low on ref gas, expansion valve, pipework damage.		
E4	P04	Outdoor unit fault, High pressure trip		

E5	P05	Problems	Outdoor unit fault, Open phase on power supply. Check power on each phase, inverter pcb, control pcb	
E9	P09		Indoor unit fault, Ceiling panel incorrectly wired	
EA	P10		Indoor unit fault, Condensate float switch opened	
EB	P11		GHP - Water Heat exchanger low temp (frost protection) fault	
EC	P12		Indoor unit fault, Fan DC motor fault	
EE	P14		Input from leak detector (If fitted)	
EF	P15		Refrigerant loss, high discharge temp and EEV wide open and low compressor current draw.	
F0	P16		Outdoor unit fault, Open phase on compressor power supply	
F1	P17		Outdoor unit fault, Compressor discharge temperature too high (Comp2) over 111 °C. Low on ref gas, expansion valve, pipework damage.	
F2	P18		Outdoor unit fault, By-pass valve failure	
F3	P19		Outdoor unit fault, 4 way valve failure, i/door temp rises in cooling or fills in heating. Check wiring, coil, pcb output, valve operation.	
F4	P20		Ref gas, high temp/pressure fault, heat exchanger temp high C2, 55-60 °C, cooling over-load, sensor fault.	
F6	P22		Outdoor unit fan motor fault, fan blade jammed, check connections, does fan turn freely, motor resistance 30-40ohm on each pair, no fan fault, yes pcb fault.	
FA	P26		Indoor Unit Problems	Outdoor unit fault, Compressor overcurrent - check winding resistance, Inverter failure - check internal resistance term HIC + & - to UVW 200-300Kohm or more
FD	P29			Outdoor unit fault, Inverter circuit fault - Motor-current Detection Circuit (MDC) fault, check comp windings, sensors C1 & TS, if ok possible pcb failure.
FE	P30	Indoor unit fault, System controller detected fault on sub indoor unit		
FF	P31	Simultaneous operation multi control fault, Group controller fault		
65535 (-1)	N/A	PA-RC2-MBS-1		Error in the communication of PA-RC2-MBS-1 device with the AC unit

In case to detect an error code not listed, contact your closest Panasonic/Sanyo technical support service.