



SM-RC-MBS-1

v.0.3

Modbus RTU (EIA-485) Interface for Samsung air conditioners.
Compatible with commercial air conditioners commercialized by Samsung.

User Manual

Issue Date: 11/2017
r1.2 EN

Order Code:

SM-RC-MBS-1: Modbus RTU Interface for Samsung air conditioners

© Intesis Software S.L.U. 2017. All Rights Reserved.

Information in this document is subject to change without notice. No part of this publication may be reproduced, stored in a retrieval system or transmitted in any form or any means electronic or mechanical, including photocopying and recording for any purpose other than the purchaser's personal use without the written permission of Intesis Software S.L.U.

Intesis Software S.L.U.
Milà i Fontanals, 1 bis
08700 Igualada
Spain

TRADEMARKS

All trademarks and tradenames used in this document are acknowledged to be the copyright of their respective holders.

INDEX

- 1. Presentation 4
- 2. Connection 5
 - 2.1 Connect to the AC indoor unit 5
 - 2.2 Connection to the EIA-485 bus 6
- 3. Quick Start Guide..... 6
- 4. Modbus Interface Specification 7
 - 4.1 Modbus physical layer..... 7
 - 4.2 Modbus Registers..... 7
 - 4.2.1 Control and status registers 7
 - 4.2.2 Configuration Registers..... 9
 - 4.2.3 Considerations on Temperature Registers 10
 - 4.3 DIP-switch Configuration Interface 13
 - 4.4 Implemented Functions 16
 - 4.5 Device LED indicator 16
 - 4.6 EIA-485 bus. Termination resistors and Fail-Safe Biasing mechanism 17
- 5. Electrical and Mechanical features 18
- 6. List of supported AC Unit Types. 19
- 7. Error Codes 20

1. Presentation



The SM-RC-MBS-1 interfaces allow a complete and natural integration of **Samsung** air conditioners into Modbus RTU (EIA-485) networks.

Reduced dimensions. 93 x 53 x 58 mm
3.7" x 2.1" x 2.3"

Quick and easy installation.
Mountable on DIN rail, wall, or even inside the indoor unit of AC.

- External power not required.
- Direct connection to Modbus RTU (EIA-485) networks. Up to 63 SM-RC-MBS-1 devices can be connected in the same network.
SM-RC-MBS-1 is a Modbus slave device.
- Direct connection to the AC indoor unit. Up to 16 AC indoor units can be connected to SM-RC-MBS-1, controlling them as one (not individually).
- Configuration from both on-board DIP-switches and Modbus RTU.
- Total Control and Supervision.
- Real states of the AC unit's internal variables.
- Allows simultaneous use of the AC's remote controls and Modbus RTU.

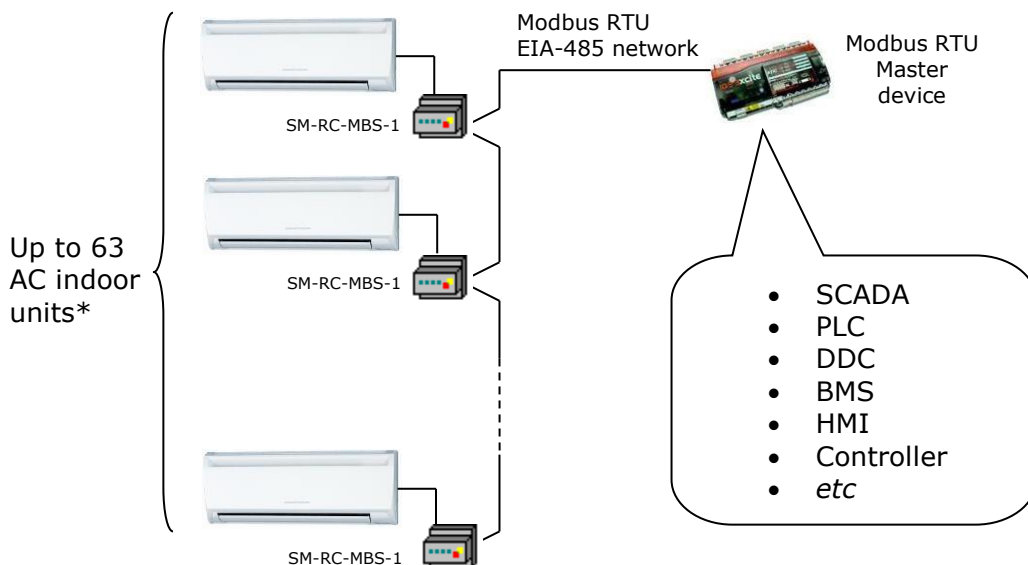

* Up to 63 IntesisBox devices can be installed in the same Modbus RTU bus. However, depending on the configured speed, the installation of Modbus Repeaters may be required

2. Connection

The interface comes with 2 plug-in terminal blocks of 2 poles each one, to establish direct connection with the AC indoor unit. It comes as well with a plug-in terminal block of 2 poles to establish direct connection with the Modbus RTU EIA-485 network.

2.1 Connect to the AC indoor unit

The SM-RC-MBS-1 connects directly to the Samsung F3F4 V1V2 bus. This bus is not provided within the interface. Depending on which controllers are available, the recommended connection methods are the following ones (details in Figure 2. 1):

- **Wired remote control available.** Connect the gateway as Slave in parallel with the wired Remote Controllers (Remote Controller acts as Master).
- **No remote control available** Connect the gateway directly to the F3F4 V1V2 bus of the indoor unit as Master when there is no Samsung Remote Controller.

Maximum F3F4 V1V2 bus length is 100 m / 328.08 ft. The communication F3F4 V1V2 bus has polarity sensitivity.

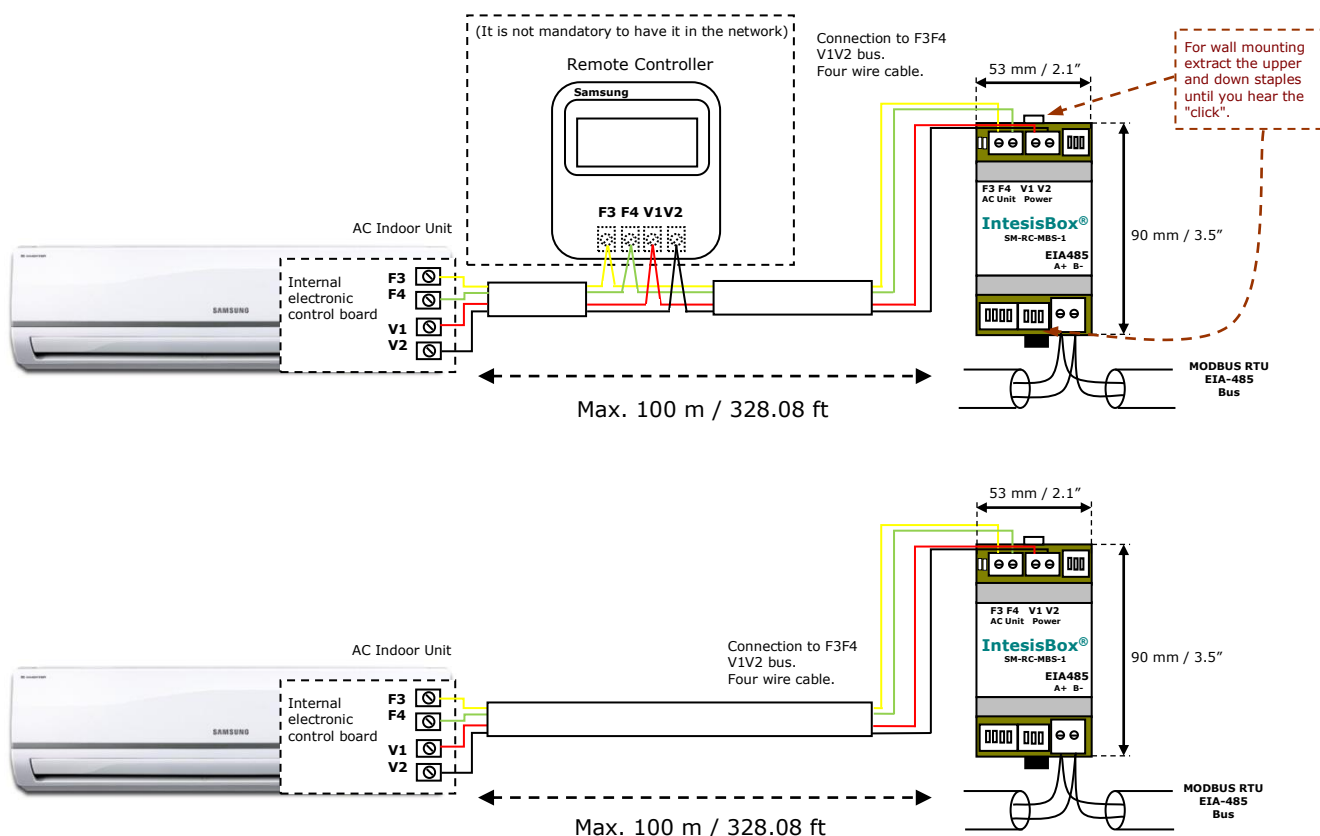

Figure 2. 1 SM-RC-MBS-1 connection diagram

2.2 Connection to the EIA-485 bus

Connect the EIA-485 bus wires to the plug-in terminal block (the one of two poles) of SM-RC-MBS-1 and keep the polarity on this connection (A+ and B-). Make sure that the maximum distance to the bus is 1,200 meters (3,937 ft). Loop or star typologies are not allowed in the case of the EIA-485 bus. A terminator resistor of 120Ω must be present at each end of the bus to avoid signal reflections. The bus needs a fail-safe biasing mechanism (see section 4.6 for more details).

3. Quick Start Guide

1. Disconnect the air conditioning from the Mains Power.
2. Attach the interface next to the AC indoor unit (wall mounting) following the instructions of the diagram below or install it inside the AC indoor unit (respect the safety instructions given).
3. Connect the F3F4 V1V2 bus between the interface and the AC indoor unit following the instructions of the diagram. Screw each bare cable end in the corresponding F3F4 V1V2 terminals.
4. Connect the EIA-485 bus to the connector *EIA485* of the interface.
5. Close the AC indoor unit.
6. Check the DIP-Switch configuration of the IntesisBox interface and make sure it matches the current installation's parameters (see section 4.3).

By default, the interface is set to:

- Modbus Slave Address → 1
- Modbus baud rate → 9600 bps



These parameters can be modified from SW4 and SW3 DIP-Switches.

All other switch positions are set at low level (Off position ) by default.

NOTE: All changes on the DIP-Switch configuration require a system power cycle to be applied.

7. Connect the AC system to Mains Power.

IMPORTANT: The IntesisBox interface requires to be connected to the AC unit (powered) to start communicating.

4. Modbus Interface Specification

4.1 Modbus physical layer

SM-RC-MBS-1 implements a Modbus RTU (Slave) interface, to be connected to an EIA-485 line. It performs 8N2 communication (8 data bits, no parity and 2 stop bit) with several available baud rates (2400 bps, 4800 bps, 9600 bps -default-, 19200 bps, 38400 bps, 57600 bps, 76800 bps and 115200 bps). It also supports 8N1 communication (8 data bits, no parity and 1 stop bit).

4.2 Modbus Registers

All registers are type "16-bit unsigned Holding Register" and they use the *Modbus big endian* notation.

4.2.1 Control and status registers

Register Address (protocol address)	Register Address (PLC address)	R/W	Description
0	1	R/W	AC unit On/Off <ul style="list-style-type: none"> ▪ 0: Off ▪ 1: On
1	2	R/W	AC unit Mode ¹ <ul style="list-style-type: none"> ▪ 0: Auto ▪ 1: Heat ▪ 2: Dry ▪ 3: Fan ▪ 4: Cool
2	3	R/W	AC unit Fan Speed ¹ <ul style="list-style-type: none"> ▪ 0: Auto ▪ 1: Low ▪ 2: Mid ▪ 3: High
3	4	R/W	AC unit Vane Position ¹ <ul style="list-style-type: none"> ▪ 0: Auto ▪ 10: Swing
4	5	R/W	AC unit Temperature setpoint ^{1,2,3} <ul style="list-style-type: none"> ▪ -32768 (Initialization value) ▪ 18..30°C (°C/x10°C) ▪ 65..86°F
5	6	R	AC unit Temperature reference ^{1,2,3} <ul style="list-style-type: none"> ▪ -32768 (Initialization value) ▪ 10..38°C (°C/x10°C) ▪ 50..100°F
6	7	R/W	Window Contact <ul style="list-style-type: none"> ▪ 0: Closed (Default) ▪ 1: Open

¹ Available values will depend on the AC unit mode. Check the AC unit model functions in its user manual to know the possible values for this register.

² Magnitude for this register can be adjusted to Celsius x 10°C, Celsius x 10°C (default) or Fahrenheit. See section 4.2.3 for more information.

³ It is not possible turn to x10 the value shown in Fahrenheit.

Register Address (protocol address)	Register Address (PLC address)	R/W	Description
7	8	R/W	SM-RC-MBS-1 Disablement ⁴ <ul style="list-style-type: none"> 0: SM-RC-MBS-1 enabled (Default) 1: SM-RC-MBS-1 disabled
8	9	R/W	AC Remote Control Disablement ⁴ <ul style="list-style-type: none"> 0: Remote Controller enabled (Default) 1: Remote Controller disabled
9	10	R/W	AC unit Operation Time ⁴ <ul style="list-style-type: none"> 0..65535 (hours). Counts the time the AC unit is in "On" state.
10	11	R	AC unit Alarm Status <ul style="list-style-type: none"> 0: No alarm condition 1: Alarm condition
11	12	R	Error Code ⁵ <ul style="list-style-type: none"> 0: No error present 65535(-1 if it is read as signed value): Error in the communication of SM-RC-MBS-1 or Remote Controller with the AC indoor unit. Any other error present, see the table at the end of this document.
22	23	R/W	Indoor unit's ambient temperature from external sensor (at Modbus side) ^{1,2,3,6} <ul style="list-style-type: none"> -32768: (Initialization value). No temperature is being provided from an external sensor. Any other: (°C/x10°C/°F)
23	24	R	AC Real temperature setpoint ^{1,2,3,6} <ul style="list-style-type: none"> When no external temperature is provided, this read-only register will have the same value as register 5 (PLC addressing). In all cases, it will show the current setpoint in the indoor unit. Ranges determined by the Manufacturer of the AC indoor unit: (°C/x10°C/°F)
26	27	R/W	AC unit Left/Right Vane Position <ul style="list-style-type: none"> 0: Auto (Default) 10: Swing
66	67	R	Return path Temperature ^{1,2,3} <ul style="list-style-type: none"> -32768 (Initialization value) Ranges determined by the Manufacturer of the AC indoor unit: (°C/x10°C/°F)
97	98	R/W	Block Periodic Sendings ^{4,7,8} <ul style="list-style-type: none"> 0: Non-blocked (Default value) 1: Blocked
98	99	R/W	Master/Slave (gateway) <ul style="list-style-type: none"> 0: Slave 1: Master

⁴ This value is stored in non-volatile memory

⁵ See section 7 for possible error codes and their explanation

⁶ See section 4.2.3 for more information

⁷ If the register is configured as "0:Non-blocked", all commands received from Modbus will be sent to the AC system. If "1: Blocked", commands from Modbus will only be sent to the AC system if they differ from the previous value (values sent on change).

⁸ This register applies to firmware version 0.3 onwards.

4.2.2 Configuration Registers

Register Address (protocol address)	Register Address (PLC address)	R/W	Description
13	14	R/W	"Open Window" switch-off timeout ⁹ <ul style="list-style-type: none"> 0..30 (minutes) Factory setting: 30 (minutes)
14	15	R	Modbus RTU baud-rate <ul style="list-style-type: none"> 2400bps 4800bps 9600bps (Default) 19200bps 38400bps 57600bps 76800bps 115200bps
15	16	R	Modbus Slave Address <ul style="list-style-type: none"> 1..63
21	22	R	Max number of fan speeds
49	50	R	Device ID: 0x1200
50	51	R	Software version
67	68	R	Number of IUs connected
81	82	R	Error Address
99	100	W	Reset/Reboot device <ul style="list-style-type: none"> 1: Reset

⁹ Once window contact is open, a count-down to switch off the AC Unit will start from this configured value.

4.2.3 Considerations on Temperature Registers

- **AC unit temperature setpoint (R/W)**
(register 4 – in Protocol address / register 5 – in PLC address):
This is the adjustable temperature setpoint value that must be required by the user. This register can be read (Modbus function 3 or 4) or written (Modbus functions 6 or 16). A remote controller connected to the Samsung indoor unit will report the same temperature setpoint value as this register, but only will happen when no AC unit's external reference is provided from SM-RC-MBS-1 (see detail for register 22/23 below).
- **AC unit temperature reference (R)**
(register 5 – in Protocol address / register 6 – in PLC address):
This register reports the temperature that is currently used by the Samsung indoor unit as the reference of its own control loop. Depending on the configuration of the indoor unit, this value can be the temperature reported by the sensor on the return path of the Samsung indoor unit or the sensor of its remote controller. It is a read-only register (Modbus functions 3 or 4).
- **AC unit external temperature reference (Modbus) (R/W)**
(register 22 – in Protocol address / register 23 – in PLC address):
This register allows us to provide an external temperature's sensor from the Modbus side. Samsung indoor unit does not allow on devices like SM-RC-MBS-1 to provide directly temperature to be used as a reference of the control loop of the AC indoor unit. In order to overcome this limitation and enable the usage of an external temperature sensor (i.e. from Modbus side), SM-RC-MBS-1 applies the following mechanism (only if "external temperature's reference" is being used):
 - After a couple of values have been entered in the "AC unit external temperature's reference" (register 22/23) and "AC unit temperature set point" (register 4/5), SM-RC-MBS-1 is going to estimate the temperature chosen implied (e.g. if a "temperature setpoint (register 4/5)" of **22°C**, and an "external temperature reference (register 22/23)" of **20°C** are entered, SM-RC-MBS-1 will assume that the user is demanding a **+2°C** increase in temperature).
 - By knowing at any time the ambient temperature currently used by the indoor unit to control its own operation (register 5/6), SM-RC-MBS-1 can calculate the required temperature setpoint needed to apply the decrease/increase on the real temperature and reach the temperature chosen by the user (following the example above, if SM-RC-MBS-1 reads an "ambient temperature" (register 5/6) of **24°C** in the indoor unit, it will apply a final setpoint of **24°C + 2°C = 26°C**).
 - At this moment, each time that SM-RC-MBS-1 detects a change on the ambient temperature reported by the indoor unit (register 5/6), it will also change the required setpoint, in order to keep the temperature required by the user at any time. If we follow the last example, if SM-RC-MBS-1 receives a new temperature's value coming from the indoor unit of **25°C**, SM-RC-MBS-1 will automatically adjust the temperature setpoint required of the AC indoor unit to **25°C + 2°C = 27°C**).
 - In general, SM-RC-MBS-1 is constantly applying the "Virtual Temperature" formula:

$$S_{AC} = S_u - (T_u - T_{AC})$$

Where:

- S_{AC} - setpoint value currently applied to the indoor unit
- S_u - setpoint value written at Modbus side (register 4/5)
- T_u - external temperature reference written at Modbus side (register 22/23)
- T_{AC} - ambient temperature that the indoor unit is using as the reference of its own control loop (register 5/6)

When SM-RC-MBS-1 detects a change in any of the values of $\{ S_u, T_u, T_{AC} \}$, it will send the new setpoint (S_{AC}) to the indoor unit.

- After the startup, the value for "external temperature's reference" (register 22/23) has a value -32768 (0x8000). This value means that no external temperature reference is being provided through SM-RC-MBS-1. In this scenario, the setpoint value shown in register 4/5 will always be the same as the current setpoint value of the indoor unit. AC indoor unit will use its own return path temperature sensor as reference for its control loop.
 - When the mechanism of "Virtual Temperature" is applied. The temperature setpoint's value shown by the Remote Controller or other Control System from Samsung connected to the indoor unit may show a different value from the value shown in register 4/5.
 - If it is desired to use the temperature's reading from the Remote Control as the external temperature reference (T_u , register 22/33), the Remote Controller must be configured as Master, and the Samsung AC indoor unit must have the option "thermostat sensor in the Remote Controller" as activated. This configuration is done via a Samsung Remote Controller connected to the indoor unit and must be done by Samsung authorized installers while the AC is being installed.
 - This configuration is done following the instructions from the Service Manual of Samsung (In Service Mode: Main Menu **1**, press [$>$] button to Sub Menu **2** (= "Function Wireless Remote Control Option setting"); press [$>$] button data-bit **1** (= "Temperature sensor selection") set value **1**-Wired Remote Controller). This configuration is done via a Samsung Remote Controller connected to the indoor unit and must be done by Samsung authorized installers while the AC is being installed.
 - When SM-RC-MBS-1 is set as "Master" of F3F4 V1V2 bus, the external temperature's sensor connected to Modbus RTU EIA-485 network provides directly the value currently applied to the indoor unit (S_{AC}), and the process of the Virtual temperature is not applied. In this case, the Remote Controller or any other Control System connected from Samsung is not able to send the external temperature reference's value to the register 22/23.
- **AC Real temperature setpoint (R)**
(register 23 – In Protocol address / register 24 – in PLC address):
As it has been detailed on the previous point, the real temperature setpoint in the indoor unit and the temperature setpoint requested from SM-RC-MBS-1 might differ (when a value in register 22/23 – "external temperature reference" is entered). This register always informs about the current temperature setpoint which is being used by the indoor unit – it also includes the temperature setpoint that will be shown by an additional remote controller from Samsung connected to the indoor unit, if it is present on the system.

Moreover, notice that temperature's values of all these four registers are expressed according to the temperature's format configured through its onboard DIP-Switches (See "4.3 -

DIP-switch Configuration Interface"). These following formats are possible:

- **Celsius value:** Value in Modbus register is the temperature value in Celsius (i.e. a value "22" in the Modbus register must be interpreted as 22°C).
- **Decicelsius value:** Value in Modbus register is the temperature value in decicelsius (i.e. a value "220" in the Modbus register must be interpreted as 22.0°C).
- **Fahrenheit value:** Value in Modbus register is the temperature value in Fahrenheit (i.e. a value "72" in the Modbus register must be interpreted as 72°F (~22°C)).

4.3 DIP-switch Configuration Interface

All the configuration values on SM-RC-MBS-1 can be written and read from Modbus interface. Otherwise, some of them can also be setup from its on-board DIP-switch interface. The device has DIP-switches SW1, SW3 and SW4 on the following locations:

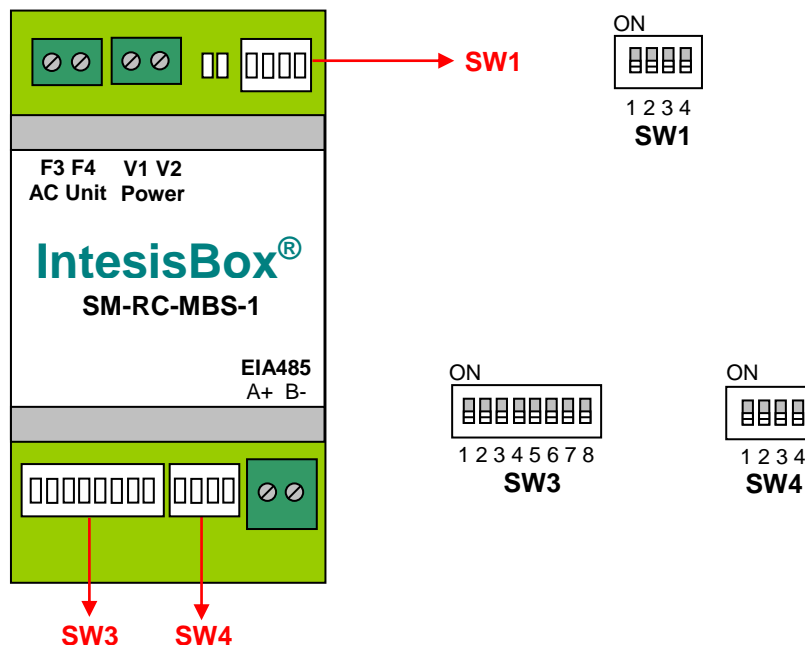

The following tables apply to the interface's configuration through DIP-switches:

SW1 – AC indoor unit's features

SW1-P1..4	Description
	Slave - A Samsung Controller must be present in F3F4 V1V2 bus, configured as Master (Default value)
	Master – Samsung Controller not needed in F3F4 V1V2 bus. If it exists, it must be configured as Slave
	Not used (Default value)
	Not used
	Not used (Default value)
	Not used
	Not used (Default value)
	Not used

Table 4.1 SW1: AC indoor unit's features

SW3/SW4 – Baud rate configuration















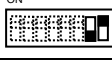

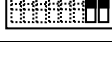
SW3-P7..8	SW4-P3	Description
		2400bps
		4800bps
		9600bps (Default value)
		19200bps
		38400bps
		57600bps
		76800bps
		115200bps

Table 4.2 SW3-SW4: Modbus baud rate

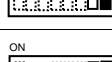
SW4 – Degrees/Decidegrees (x10), temperature magnitude (°C/°F) and EIA-485 termination resistor.

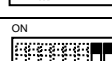





SW4-P1..2-4	Description
	Temperature values in Modbus register are represented in degrees (x1) (Default value)
	Temperature values in Modbus register are represented in decidegrees (x10)
	Temperature values in Modbus register are represented in Celsius degrees (Default value)
	Temperature values in Modbus register are represented in Fahrenheit degrees
	EIA-485 bus without termination resistor (Default value)
	Internal termination resistor of 120Ω connected to EIA-485 bus

Table 4.3 SW4: Temperature and termination resistor configuration

SW3 – Modbus Slave address

Add	SW3-P1..6	Add	SW3-P1..6	Add	SW3-P1..6	Add	SW3-P1..6	Add	SW3-P1..6
0		13		26		39		52	
1		14		27		40		53	
2		15		28		41		54	
3		16		29		42		55	
4		17		30		43		56	
5		18		31		44		57	
6		19		32		45		58	
7		20		33		46		59	
8		21		34		47		60	
9		22		35		48		61	
10		23		36		49		62	
11		24		37		50		63	
12		25		38		51			

Table 4.4 SW3: Modbus slave address

4.4 Implemented Functions

SM-RC-MBS-1 implements the following standard Modbus functions:

- 3: Read Holding Registers
- 4: Read Input Registers
- 6: Write Single Register
- 16: Write Multiple Registers (Despite this function is allowed, the interface does not allow to write operations on more than 1 register with the same request, this means that length field should be always be 1 when this function is being used in case of writing).

The maximum of registers that can be read in a single request is 100.

4.5 Device LED indicator

The device includes two LED indicators to show all the possible operational states. In the following table there are written the indicators which can be performed and their meaning.

L1 (green LED)

Device status	LED indication	ON / OFF Period	Description
During not normal operation	LED blinking	500ms ON / 500ms OFF	Communication error
During normal operation	LED flashing	100ms ON / 1900ms OFF	Normal operation (configured and working properly)

L2 (red LED)

Device status	LED indication	ON / OFF Period	Description
During not normal operation	LED Pulse	3sec ON / --- OFF	Under voltage

L1 (green LED) & L2 (red LED)

Device status	LED indication	ON / OFF Period	Description
During normal operation	LED Pulse	5sec ON / --- OFF	Device Start-up
During not normal operation	LED alternatively blinking	500ms ON / 500ms OFF	Flash checksum not OK

4.6 EIA-485 bus. Termination resistors and Fail-Safe Biasing mechanism

EIA-485 bus requires a 120Ω terminator resistor at each end of the bus to avoid signal reflections.

In order to prevent fail status detected by the receivers, which are "*listening*" the bus, when all the transmitters' outputs are in three-state (high impedance), it is also required a fail-safe biasing mechanism. This mechanism provides a safe status (a correct voltage level) in the bus when all the transmitters' outputs are in three-state. This mechanism must be supplied by the Modbus Master.

The SM-RC-MBS-1 device includes an on-board terminator resistor of 120Ω that can be connected to the EIA-485 bus by using DIP-switch SW4.

Some Modbus RTU EIA-485 Master devices can provide also internal 120Ω terminator resistor and/or fail-safe biasing mechanism (Check the technical documentation of the Master device connected to the EIA-485 network in each case).

5. Electrical and Mechanical features

Enclosure	Plastic, type PC (UL 94 V-0) Net dimensions (dxwxh): 93 x 53 x 58 mm / 3.7" x 2.1" x 2.3" Color: Light Grey. RAL 7035	Operation Temperature	0°C to +60°C
Weight	85 g.	Stock Temperature	-20°C to +85°C
Mounting	Wall DIN rail EN60715 TH35.	Operational Humidity	<95% RH, non-condensing
Terminal Wiring (for low-voltage signals)	For terminal: solid wires or stranded wires (twisted or with ferrule) 1 core: 0.5mm ² ... 2.5mm ² 2 cores: 0.5mm ² ... 1.5mm ² 3 cores: not permitted	Stock Humidity	<95% RH, non-condensing
Modbus RTU port	1 x Serial EIA485 Plug-in screw terminal block (2 poles): A, B Compatible with Modbus RTU EIA-485 networks	Isolation voltage	1500 VDC
AC unit port	1 x F3F4 bus Plug-in screw terminal block (2 poles): F3, F4 Compatible with Samsung networks 1 x V1V2 Power screw terminal block (2 poles): V1, V2	Isolation resistance	1000 MΩ
Switch 1 (SW1)	1 x DIP-Switch for AC features	Protection	IP20 (IEC60529)
Switch 3 (SW3)	1 x DIP-Switch for Modbus RTU settings	LED indicators	2 x Onboard LED - Operational status
Switch 4 (SW4)	1 x DIP-Switch for extra functions		

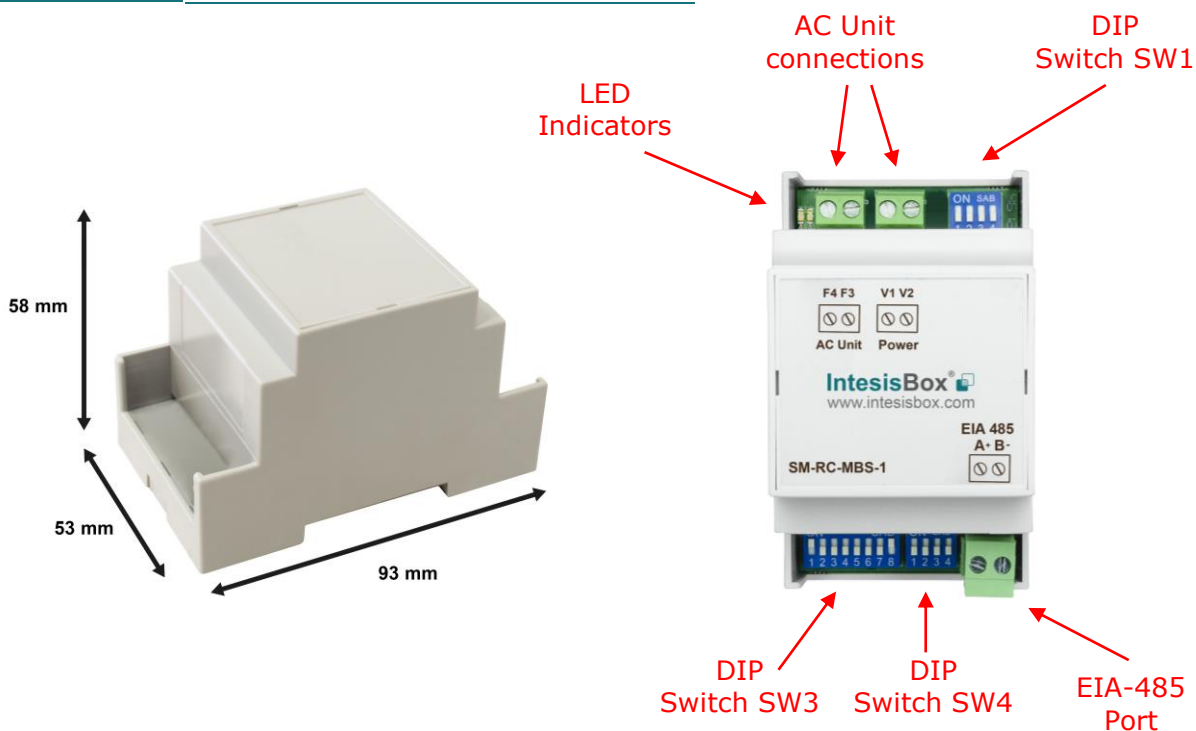

6. List of supported AC Unit Types.

A list of Samsung indoor unit model's references compatible with SM-RC-MBS-1 and its available features can be found on this link:

https://www.intesisbox.com/intesis/support/compatibilities/IntesisBox_SM-RC-xxx-1_Compatibility.pdf

7. Error Codes

Error Code Modbus	Error in Remote Controller	Error category	Error Description
0	N/A	SM-RC-MBS-1	No active error
101	101	Communication error	Indoor unit communication error
102	102	Communication error	Indoor unit/outdoor unit communication time-out error; errors in more than 6 packets.
121	121	Indoor sensor error	Indoor temperature sensor (open/short).
122	122	Indoor sensor error	Indoor unit evaporator-in sensor (open/short)
128	128	Indoor sensor error	Indoor unit evaporator-in disconnection. (sensor displacement)
129	129	Indoor sensor error	Indoor unit evaporator-out separation.
153	153	Drain diagnostic error	Indoor floating switch secondary detection
201	201	Configuration error	Unit Miss Match indoor/outdoor
202	202	Communication error	Indoor/outdoor communication error (1 min)
203	203	Communication error	Comm. error between indoor/outdoor INV<>MAIN MICOM (1 min)
221	221	Outdoor sensor error	Outdoor temperature sensor error
231	231	Outdoor sensor error	Condenser temperature sensor error
237	237	Outdoor sensor error	Condenser temperature error
251	251	Outdoor sensor error	Inverter Emission temperature sensor error
320	320	Outdoor sensor error	OPL sensor error
402	402	Outdoor sensor error	Detection of outdoor freezing when compressor stop
404	404	Outdoor unit error	Overload Protection of Outdoor when compressor stop
419	419	Control error	EEV Open error (Electronic Evaporation Valve)
422	422	Control error	EEV Close error
425	425	Installation error	Power Cable Miss connection
440	440	Self-diagnostic error	Heating operation blocked
441	441	Self-diagnostic error	Cooling operation blocked
461	461	ODU protection error	Inverter Compressor startup error
462	462	ODU protection error	Inverter total current error / PFC over current error
463	463	ODU protection error	OLP Heat Sink error
464	464	ODU protection error	Inverter IPM over current error
465	465	ODU protection error	Compressor V limit error
466	466	ODU protection error	DC LINK over/low voltage error
467	467	ODU protection error	Inverter compressor rotation error
468	468	ODU protection error	Inverter current sensor error
469	469	ODU protection error	Inverter DC LINK voltage sensor error
471	471	ODU protection error	Inverter OTP error / Inverter EEPROM read/write error
472	472	ODU protection error	AC Zero crossing signal out error
473	473	ODU protection error	Compressor Lock error
474	474	ODU protection error	Heat Sink sensor error
475	475	Self-diagnostic error	Outdoor Fan 2 error
484	484	ODU protection error	PFC Overload error
485	485	ODU protection error	Input current sensor error
500	500	ODU protection error	Heat Sink Over Heat error
554	554	Self-diagnostic error	Gas leak detector
556	556	Configuration error	Outdoor unit Capacity Setup option error
557	557	Configuration error	Option Code Miss match indoor units
601	601	Communication error	Communication error between wired remote and

			indoor unit. (When communication has stopped for 3 minutes after detecting indoor unit and wired remote control)
602	602	Communication error	Communication error between the Master and Slave wired remote controller. (Only one Master and one Slave can exist).
604	604	Communication error	Tracking 10 or more errors between wired remote control and indoor unit.
606	606	Installation error	-COM1, Com2 crossing connection error. -When wired remote is connected to indoor unit COM1 (F1, F2) terminals.
607	607	Configuration error	-Multiple Master error. (When using Master remote control). -Error occurs when two wired remotes are both set as Master in one COM line.
609	609	Configuration error	Indoor unit is not installed. (when the indoor unit is not detected after outside gearing option setting and tracking are finished). In case of using outside gear control.
618	618	Configuration error	-Exceeded maximum no. of installation for indoor units. -A reset is required after checking the number of indoor unit.
619	619	Configuration error	-Mixed installations for °C/°F indoor unit. (Only detected on master wired remote control). -Error occurs when mixed indoor units of °C and °F settings are installed.
620	620	Configuration error	-Wired remote control °C/°F setting error. -This error occurs if the indoor unit is set in °C while the wired remote is set in °F or vice versa.
621	621	Configuration error	This error occurs when the option setting of the Master and Slave wired remote controls are different from each other.
627	627	Configuration error	Slave wired remote control installation error (when two Slave wired remote controls are installed).
EA	EA	Configuration error	Wired remote controller COM2 option setting error.
65535 (-1)	N/A	SM-RC-MBS-1	Error in the communication of SM-RC-MBS-1 or Remote Controller with the AC unit.

In case to detect an error code not listed, contact your closest Samsung technical support service.