



TO-RC-MBS-1

v.2.3

Modbus RTU (EIA-485) Interface for Toshiba air conditioners.
Compatible with Digital Inverter & VRF lines.

User Manual

Issue Date: 04/2019
r2.6 EN

Order Codes:

TO-RC-MBS-1: Modbus RTU Interface for Toshiba

© Intesis Software S.L.U.**All Rights Reserved.**

Information in this document is subject to change without notice. No part of this publication may be reproduced, stored in a retrieval system or transmitted in any form or any means electronic or mechanical, including photocopying and recording for any purpose other than the purchaser's personal use without the written permission of Intesis Software S.L.U.

Intesis Software S.L.U.
Milà i Fontanals, 1 bis
08700 Igualada
Spain

TRADEMARKS

All trademarks and tradenames used in this document are acknowledged to be the copyright of their respective holders.

INDEX

- 1. Presentation 4
- 2. Connection 5
 - 2.1 Connect to the AC indoor unit 5
 - 2.2 Connection to the EIA-485 bus 6
- 3. Quick Start Guide..... 6
- 4. Modbus Interface Specification 7
 - 4.1 Modbus physical layer..... 7
 - 4.2 Modbus Registers..... 7
 - 4.2.1 Control and status registers 7
 - 4.2.2 Configuration Registers..... 9
 - 4.3 Modbus Registers for Advanced Functions 10
 - 4.3.1 Advanced registers for Indoor Unit status 10
 - 4.3.2 Advanced registers for Outdoor Unit Status on VRF-SMMSi Systems..... 11
 - 4.3.3 Advanced registers for Outdoor Unit Status on VRF-SHRM/SMMS Systems 12
 - 4.3.4 Advanced registers for Outdoor Unit Status on RAV Systems 14
 - 4.3.5 Advanced registers for Indoor Unit Type and Refresh Time adjustment 15
 - 4.3.6 Considerations on Temperature Registers 16
 - 4.4 DIP-switch Configuration Interface 18
 - 4.5 Implemented Functions 21
 - 4.6 Device LED indicator..... 21
 - 4.7 EIA-485 bus. Termination resistors and Fail-Safe Biasing mechanism 22
- 5. Electrical and Mechanical features 23
- 6. List of supported AC Unit Types. 24
- 7. Error Codes 25

1. Presentation



The TO-RC-MBS-1 interfaces allow a complete and natural integration of **Toshiba** air conditioners into Modbus RTU (EIA-485) networks.

Compatible with Digital Inverter & VRF lines.

Reduced dimensions. 93 x 53 x 58 mm
3.7" x 2.1" x 2.3"

- Quick and easy installation.
Mountable on DIN rail, wall, or even inside the indoor unit of AC.
- External power not required.
- Direct connection to Modbus RTU (EIA-485) networks. Up to 63 TO-RC-MBS-1 devices can be connected in the same network.
TO-RC-MBS-1 is a Modbus slave device.
- Direct connection to the AC indoor unit. Up to 16 AC indoor units can be connected to TO-RC-MBS-1, controlling them as one (not individually).
- Configuration from both on-board DIP-switches and Modbus RTU.
- Total Control and Supervision.
- Real states of the AC unit's internal variables.
- Allows simultaneous use of the AC's remote controls and Modbus RTU.

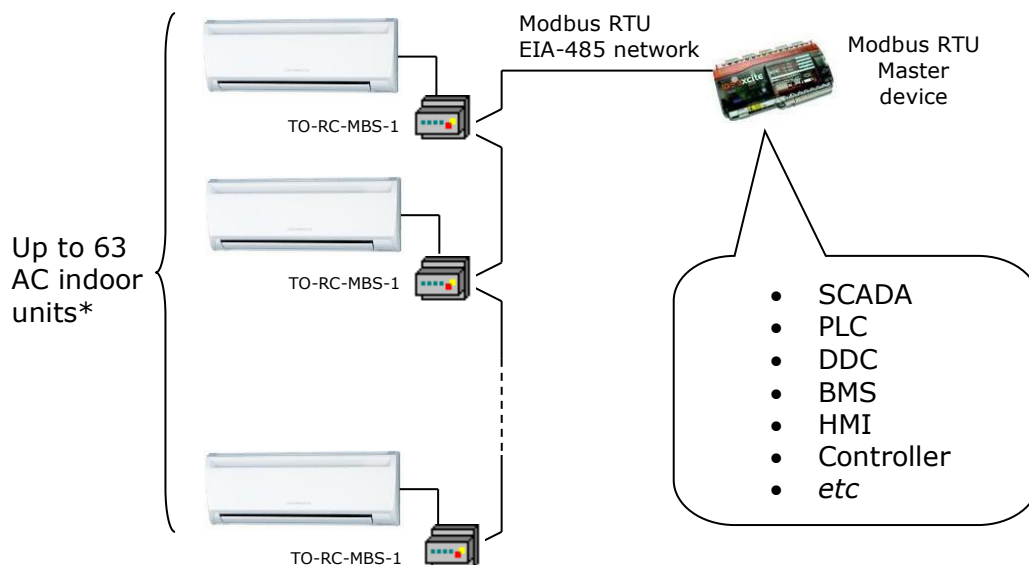

* Up to 63 IntesisBox devices can be installed in the same Modbus RTU bus. However, depending on the configured speed, the installation of Modbus Repeaters may be required

2. Connection

The interface comes with a plug-in terminal block of 2 poles to establish direct connection with the AC indoor unit. It comes as well with a plug-in terminal block of 2 poles to establish direct connection with the Modbus RTU EIA-485 network.

2.1 Connect to the AC indoor unit

The TO-RC-MBS-1 connects directly to the Toshiba AB Bus, which is not provided within the interface. The recommended connection methods are the following ones (details in Figure 2.1):

- **Wired remote control available.**
- **No remote control available**

Maximum AB bus length is 500 m / 1,640.42 ft. The bus has no polarity sensitivity.

Important: If a wired remote controller of the AC manufacturer is connected in the same bus, communication may shut down.

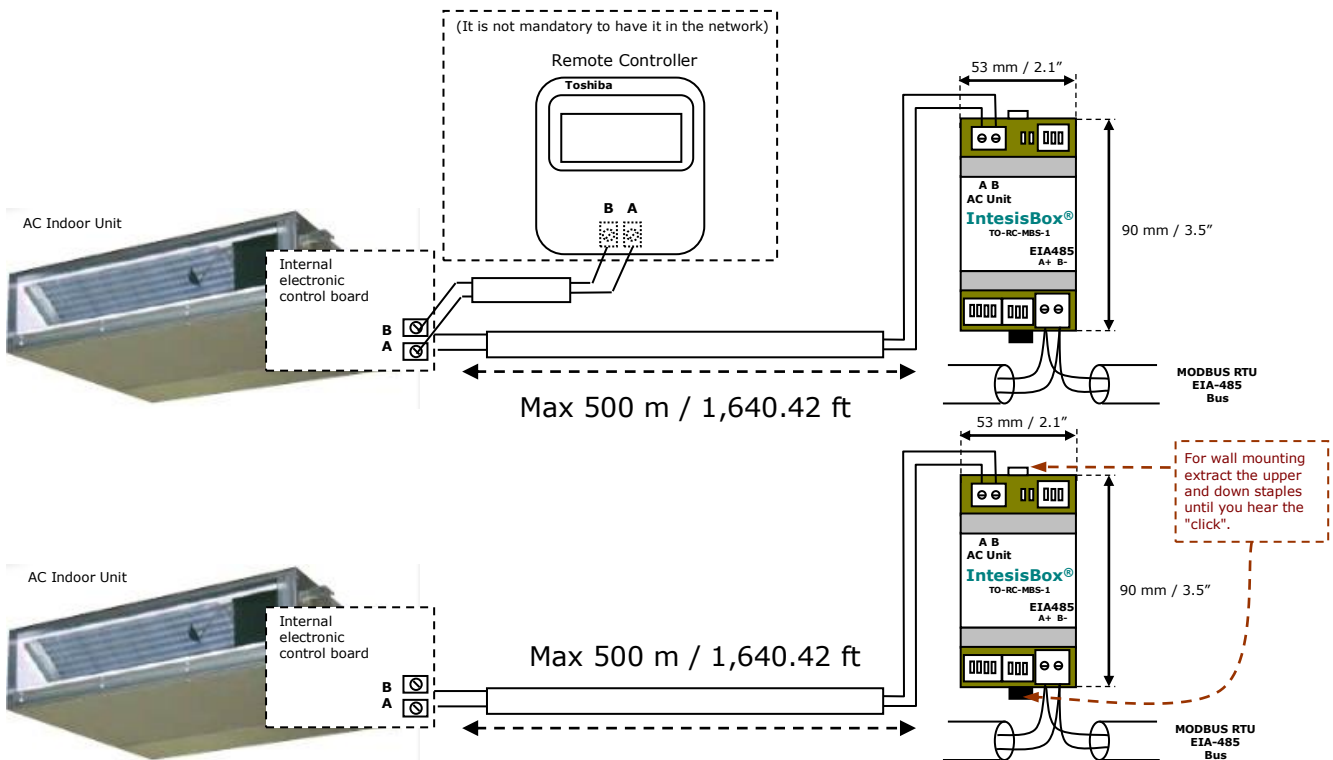

Figure 2. 1 TO-RC-MBS-1 connection diagram

IMPORTANT: In case to have a Toshiba's Remote Controller (not mandatory) installed in the network, the DIP switch of the Toshiba's Remote Controller should be always set into *Followe*r position.

Rear's view of the Toshiba's Remote Controller



Switch	Function
1 2	Toshiba's Remote Controller as <i>Followe</i> r.

2.2 Connection to the EIA-485 bus

Connect the EIA-485 bus wires to the plug-in terminal block of TO-RC-MBS-1 and keep the polarity on this connection (A+ and B-). Make sure that the maximum distance to the bus is 1,200 meters (3,937 ft). Loop or star typologies are not allowed in the case of the EIA-485 bus. A terminator resistor of 120Ω must be present at each end of the bus to avoid signal reflections. The bus needs a fail-safe biasing mechanism (see section 4.7 for more details).

3. Quick Start Guide

1. Disconnect the air conditioning from the Mains Power.
2. Attach the interface next to the AC indoor unit (wall mounting) following the instructions of the diagram below or install it inside the AC indoor unit (respect the safety instructions given).
3. Connect the AB bus between the interface and the AC indoor unit following the instructions of the diagram. Screw each bare cable end in the corresponding AB terminals of each device.
4. Connect the EIA-485 bus to the connector *EIA485* of the interface.
5. Close the AC indoor unit.
6. Check the DIP-Switch configuration of the IntesisBox interface and make sure it matches the current installation's parameters (see section 4.4).

By default, the interface is set to:

- Modbus Slave Address → 1
- Modbus baud rate → 9600 bps



These parameters can be modified from SW4 and SW3 DIP-Switches.

All other switch positions are set at low level (Off position ) by default.

NOTE: All changes on the DIP-Switch configuration require a system power cycle to be applied.

7. Connect the AC system to Mains Power.

IMPORTANT: The IntesisBox interface requires to be connected to the AC unit (powered) to start communicating.

4. Modbus Interface Specification

4.1 Modbus physical layer

TO-RC-MBS-1 implements a Modbus RTU (Slave) interface, to be connected to an EIA-485 line. It performs 8N2 communication (8 data bits, no parity and 2 stop bit) with several available baud rates (2400 bps, 4800 bps, 9600 bps -default-, 19200 bps, 38400 bps, 57600 bps, 76800 bps and 115200 bps). It also supports 8N1 communication (8 data bits, no parity and 1 stop bit).

4.2 Modbus Registers

All registers are type "16-bit unsigned Holding Register" and they use the *Modbus big endian* notation.

4.2.1 Control and status registers

Register Address (protocol address)	Register Address (PLC address)	R/W	Description
0	1	R/W	AC unit On/Off <ul style="list-style-type: none"> ▪ 0: Off ▪ 1: On
1	2	R/W	AC unit Mode ¹ <ul style="list-style-type: none"> ▪ 0: Auto ▪ 1: Heat ▪ 2: Dry ▪ 3: Fan ▪ 4: Cool
2	3	R/W	AC unit Fan Speed ¹ <ul style="list-style-type: none"> ▪ 0: Auto ▪ 1: Low ▪ 2: Mid ▪ 3: High
3	4	R/W	AC unit Vane Position ¹ <ul style="list-style-type: none"> ▪ 1: POS1 (Horizontal) ▪ 2: POS2 (Horizontal) ▪ 3: POS3 (Medium) ▪ 4: POS4 (Vertical) ▪ 5: POS5 (Vertical) ▪ 6: POS6 ▪ 7: POS7 ▪ 10: Swing
4	5	R/W	AC unit Temperature Setpoint ^{1,2,3} <ul style="list-style-type: none"> ▪ -32768 (Initialization value) ▪ 16..32°C (°C/x10°C) ▪ 61..90°F

¹ Available values will depend on the AC unit mode. Check the AC unit model functions in its user manual to know the possible values for this register.

² Magnitude for this register can be adjusted to Celsius x 1°C, Celsius x 10°C (default) or Fahrenheit. See section 4.3.6 for more information.

³ It is not possible turn to x10 the value shown in Fahrenheit.

Register Address (protocol address)	Register Address (PLC address)	R/W	Description
5	6	R/W	AC unit Temperature reference ^{1,2,3} <ul style="list-style-type: none"> -32768: Initial value. Value invalid, which comes from the IU's sensor. If the value that is shown in register 22 (23 PLC) is valid, the address is going to take this value. Ranges are specific from Manufacturer (°C/x10°C/°F)
6	7	R/W	Window Contact <ul style="list-style-type: none"> 0: Closed (Default) 1: Open
7	8	R/W	TO-RC-MBS-1 Disablement ⁴ <ul style="list-style-type: none"> 0: TO-RC-MBS-1 enabled (Default) 1: TO-RC-MBS-1 disabled
8	9	R/W	AC Remote Control Disablement ⁴ <ul style="list-style-type: none"> 0: Remote Control enabled (Default) 1: Remote Control disabled
9	10	R/W	AC unit Operation Time ⁴ <ul style="list-style-type: none"> 0..65535 (hours). Counts the time the AC unit is in "On" state.
10	11	R	AC unit Alarm Status <ul style="list-style-type: none"> 0: No alarm condition 1: Alarm condition
11	12	R	Error Code ⁵ <ul style="list-style-type: none"> 0: No Error active 65535 (-1): Error in the communication of TO-RC-MBS-1 with the AC indoor unit. Any other error present, see the table at the end of this document.
22	23	R/W	Indoor unit's ambient temperature from external sensor (at Modbus side) ^{1,2,3,6} <ul style="list-style-type: none"> -32768: Initialization value. No temperature is being provided from an input sensor. There's no input sensor. Any other: (°C/x10°C/°F)
23	24	R	AC Real temperature setpoint ^{1,2,3,6} <ul style="list-style-type: none"> There's no Virtual Temperature. The value equals to the value of register 5 (6 PLC). The value which is introduced by the user is the one that the machine uses (the external sensor is able to write directly over the machine to do this operation). Ranges are specific from Manufacturer (°C/x10°C/°F)
97	98	R/W	Block Periodic Sendings ^{4,7,8} <ul style="list-style-type: none"> 0: Non-blocked (Default value) 1: Blocked

⁴ This value is stored in non-volatile memory

⁵ See section 7 for possible error codes and their explanation

⁶ See section 4.3.6 for more information

⁷ If the register is configured as "0:Non-blocked", all commands received from Modbus will be sent to the AC system. If "1: Blocked", commands from Modbus will only be sent to the AC system if they differ from the previous value.

⁸ This register applies to firmware version 2.3 onwards

4.2.2 Configuration Registers

Register Address (protocol address)	Register Address (PLC address)	R/W	Description
13	14	R/W	"Open Window" switch-off timeout ⁹ <ul style="list-style-type: none"> ▪ 0..30 (minutes) ▪ Factory setting: 30 (minutes)
14	15	R	Modbus RTU baud-rate ¹⁰ <ul style="list-style-type: none"> ▪ 2400bps ▪ 4800bps ▪ 9600bps (Default) ▪ 19200bps ▪ 38400bps ▪ 57600bps ▪ 76800bps ▪ 115200bps
15	16	R	Modbus Slave Address <ul style="list-style-type: none"> ▪ 1..63
21	22	R	Max number of fan speeds
49	50	R	Device ID: 0x1F00
50	51	R	Software version

While the initialization is ongoing, some Modbus registers indicate an undetermined value. Once the normal operation starts, they acquire its corresponding value. It is important to keep in mind that any change done during the initialization process will not have effect until it has been finished.

⁹ Once window contact is open, a count-down to switch off the AC Unit will start from this configured value.

¹⁰ The range 38400bps-115200bps applies to firmware version 2.3 onwards

4.3 Modbus Registers for Advanced Functions

4.3.1 Advanced registers for Indoor Unit status

These registers are only available when the indoor unit's type selected on SW1 is different from the default value. Please, check the Section 4.4 for more information.

NOTE: IU stands for Indoor Unit's index

Register Address (Protocol address)	Register Address (PLC address)	R/W	Description	Priority
$(IU - 1) * 25 + 4000$	$(IU - 1) * 25 + 4001$	R	Indoor Unit exist <ul style="list-style-type: none"> ▪ 0: Doesn't exist ▪ 1: Exist 	0
$(IU - 1) * 25 + 4001$	$(IU - 1) * 25 + 4002$	R	Indoor Unit address <ul style="list-style-type: none"> ▪ MSB - OU address ; LSB - IU address 	0
$(IU - 1) * 25 + 4002$	$(IU - 1) * 25 + 4003$	R	Indoor Unit duty <ul style="list-style-type: none"> ▪ 0..15 	1
$(IU - 1) * 25 + 4003$	$(IU - 1) * 25 + 4004$	R	Indoor Unit defrost <ul style="list-style-type: none"> ▪ 0: Off ▪ 1: On 	1
$(IU - 1) * 25 + 4004$	$(IU - 1) * 25 + 4005$	R	Indoor Unit filter alarm <ul style="list-style-type: none"> ▪ 0: No alarm ▪ 1: Alarm 	1
$(IU - 1) * 25 + 4005$	$(IU - 1) * 25 + 4006$	R	Indoor Unit 11hermos ON. <ul style="list-style-type: none"> ▪ 0: Cool ▪ 1: Heat 	1
$(IU - 1) * 25 + 4010$	$(IU - 1) * 25 + 4011$	R	Room temperature (During Control) <ul style="list-style-type: none"> ▪ x1 °C 	2
$(IU - 1) * 25 + 4011$	$(IU - 1) * 25 + 4012$	R	Room temperature (Remote Controller) <ul style="list-style-type: none"> ▪ x1 °C 	2
$(IU - 1) * 25 + 4012$	$(IU - 1) * 25 + 4013$	R	Indoor suction temperature (TA) <ul style="list-style-type: none"> ▪ x1 °C 	1
$(IU - 1) * 25 + 4013$	$(IU - 1) * 25 + 4014$	R	Indoor fan coil temperature (TCJ) <ul style="list-style-type: none"> ▪ x1 °C 	1
$(IU - 1) * 25 + 4014$	$(IU - 1) * 25 + 4015$	R	Indoor fan coil temperature (TC2) <ul style="list-style-type: none"> ▪ x1 °C 	1
$(IU - 1) * 25 + 4015$	$(IU - 1) * 25 + 4016$	R	Indoor fan coil temperature (TC1) <ul style="list-style-type: none"> ▪ x1 °C 	1
$(IU - 1) * 25 + 4016$	$(IU - 1) * 25 + 4017$	R	Indoor discharge temperature (TF) <ul style="list-style-type: none"> ▪ x1 °C ▪ Only for VRF systems 	0
$(IU - 1) * 25 + 4017$	$(IU - 1) * 25 + 4018$	R	Revolutions indoor fan <ul style="list-style-type: none"> ▪ RPS ▪ Only for RAV systems 	0

(IU - 1) * 25 + 4018	(IU - 1) * 25 + 4019	R	Indoor PMV opening <ul style="list-style-type: none"> ▪ x1, x10 Pulses ▪ Only for VRF systems 	1
(IU - 1) * 25 + 4019	(IU - 1) * 25 + 4020	R	Running hours indoor fan <ul style="list-style-type: none"> ▪ x100 hours ▪ Only for RAV systems 	0
(IU - 1) * 25 + 4020	(IU - 1) * 25 + 4021	R	Time filtersign <ul style="list-style-type: none"> ▪ Hours ▪ Only for RAV systems 	0
(IU - 1) * 25 + 4021	(IU - 1) * 25 + 4022	R	Estimated supply air temperature <ul style="list-style-type: none"> ▪ x1 °C ▪ Only for RAV systems 	0

4.3.2 Advanced registers for Outdoor Unit Status on VRF-SMMSi Systems

These registers are only available when the indoor unit's type selected on SW1 is different from the default value. Please, check section 4.4 for more information.

Register Address (protocol address)	Register Address (PLC address)	R/W	Description	Priority
4200	4201	R	Outdoor Unit duty <ul style="list-style-type: none"> ▪ 15 	1
4210	4211	R	High-pressure sensor detention pressure (Pd) <ul style="list-style-type: none"> ▪ X100 Mpa 	2
4211	4212	R	Low-pressure sensor detention pressure (Ps) <ul style="list-style-type: none"> ▪ X100 Mpa 	2
4212	4213	R	Compressor 1 discharge temperature (Td1) <ul style="list-style-type: none"> ▪ x1 °C 	2
4213	4214	R	Compressor 2 discharge temperature (Td2) <ul style="list-style-type: none"> ▪ x1 °C 	2
4214	4215	R	Compressor 3 discharge temperature (Td3) <ul style="list-style-type: none"> ▪ x1 °C 	2
4215	4216	R	Suction temperature (TS) <ul style="list-style-type: none"> ▪ x1 °C 	2
4216	4217	R	Outdoor fan coil temperature 1 (TE1) <ul style="list-style-type: none"> ▪ x1 °C 	2
4217	4218	R	Outdoor fan coil temperature 2 (TE2) <ul style="list-style-type: none"> ▪ x1 °C 	1
4218	4219	R	Temperature at liquid side (TL) <ul style="list-style-type: none"> ▪ x1 °C 	2
4219	4220	R	Outside ambient temperature (TO) <ul style="list-style-type: none"> ▪ x1 °C 	1
4220	4221	R	PMV1 + 2 opening <ul style="list-style-type: none"> ▪ x1 Pulse 	2
4221	4222	R	PMV4 opening <ul style="list-style-type: none"> ▪ x1 Pulse 	2
4222	4223	R	Compressor 1 current (I1) <ul style="list-style-type: none"> ▪ x10 A 	1

4223	4224	R	Compressor 2 current (I2) ▪ x10 A	2
4224	4225	R	Compressor 3 current (I3) ▪ x10 A	2
4225	4226	R	Outdoor fan current (Ifan) ▪ x10 A	2
4226	4227	R	Compressor 1 revolutions ▪ x10 RPS	2
4227	4228	R	Compressor 2 revolutions ▪ x10 RPS	2
4228	4229	R	Compressor 3 revolutions ▪ x10 RPS	2
4229	4230	R	Outdoor fan mode ▪ x1 mode	2
4230	4231	R	Compressor IPDU 1 heat sink temperature ▪ x1 °C	2
4231	4232	R	Compressor IPDU 2 heat sink temperature ▪ x1 °C	2
4232	4233	R	Compressor IPDU 3 heat sink temperature ▪ x1 °C	2
4233	4234	R	Outdoor fan IPDU heat sink temperature ▪ x1 °C	2
4234	4235	R	Heating/cooling recovery controlled *5 ▪ 0: Normal ▪ 1: Recovery controlled	2
4235	4236	R	Pressure release *5 ▪ 0: Normal ▪ 1: Recovery controlled	2
4236	4237	R	Discharge temperature release *5 ▪ 0: Normal ▪ 1: Recovery controlled	2
4237	4238	R	Follower unit release (U2/U2/U4 outdoor units) *5 ▪ 0: Normal ▪ 1: Recovery controlled	2
4238	4239	R	Outdoor unit horsepower ▪ x1 HP	0

4.3.3 Advanced registers for Outdoor Unit Status on VRF-SHRM/SMMS Systems

These registers are only available when the indoor unit's type selected on SW1 is different from the default value. Please, check section 4.4 for more information

Register Address (protocol address)	Register Address (PLC address)	R/W	Description	Priority
4200	4201	R	Outdoor Unit duty ▪ 15	1
4210	4211	R	Td1-Compressor 1 Discharge Temp. ▪ x1 °C	2

4211	4212	R	Td2-Compressor 2 Discharge Temp. ▪ x1 °C	2
4212	4213	R	Pd – High Pressure Sensor ▪ Mpa	2
4213	4214	R	Ps – Low Pressure Sensor ▪ Mpa	2
4214	4215	R	TS – Suction Temp. ▪ x1 °C	2
4215	4216	R	TE – Outdoor Heat Exchanger Temp. ▪ x1 °C	2
4216	4217	R	TL – Liquid Temp. ▪ x1 °C	2
4217	4218	R	TO – Outside ambient temperature ▪ x1 °C	1
4218	4219	R	TU – Low Pressure Saturated Temp. ▪ x1 °C	2
4219	4220	R	Compressor 1 Current ▪ A	1
4220	4211	R	Compressor 2 Current ▪ A	2
4221	4222	R	PMV1 + 2 Opening ▪ 0..100	2
4223	4224	R	Compressor 1, 2 ▪ 0: Off ▪ 1: On	2
4224	4225	R	Outdoor Fan Mode ▪ 0..31	2
4225	4226	R	Outdoor Unit Size ▪ HP	2

4.3.4 Advanced registers for Outdoor Unit Status on RAV Systems

These registers are only available when the indoor unit's type selected on SW1 is different from the default value. Please, check section 4.4 for more information

Register Address (protocol address)	Register Address (PLC address)	R/W	Description	Priority
4400	4401	R	Outdoor Unit duty ▪ 0..15	1
4410	4411	R	TE temperature (evaporator) ▪ x1 °C	2
4411	4412	R	TO temperature outdoor ▪ x1 °C	1
4412	4413	R	Compressor discharge temperature ▪ x1 °C	2
4413	4414	R	Suction temperature TS ▪ x1 °C	2
4414	4415	R	Temperature <i>thyristor</i> THS ▪ x1 °C	0
4415	4416	R	Compressor current ▪ A	1
4416	4417	R	Temperature at liquid side TL ▪ x1 °C	2
4417	4418	R	Compressor revolutions ▪ RPS	2
4418	4419	R	Revolutions lowest Fan ▪ RPS	0
4419	4420	R	Revolutions upper Fan ▪ RPS	0
4420	4221	R	Running hours compressor ▪ x100 hours	2

4.3.5 Advanced registers for Indoor Unit Type and Refresh Time adjustment

Register Addr (protocol address)	Register Addr (PLC address)	R/W	Description	Priority
4450	4451	R	Indoor Unit Type <ul style="list-style-type: none"> ▪ 0: Not defined (extra signals disabled) ▪ 1: RAV ▪ 2: VRF (SMMSi) ▪ 3: VRF (SHRM/SMMS) 	0
4451	4452	R/W	Refresh Time Adjust <ul style="list-style-type: none"> ▪ 1..4 	-

Refresh Time Adjust

This parameter indicates the cadence when reading priority signals.

Priorities are defined as follows and can't be modified:

- 0: Update on start-up
- 1: High priority
- 2: Low priority

The higher the value, the fastest the priority signals are going to update.

The cadence is defined by:

- 1: One high priority signal and one low priority signal's poll.
- 2: Two high priority signals and one low priority signal's poll.
- 3: Three high priority signals and one low priority signal's poll.
- 4: Four high priority signals and one low priority signal's poll.

4.3.6 Considerations on Temperature Registers

- **AC unit temperature setpoint (R/W)**

(register 4 – in Protocol address / register 5 – in PLC address):

This is the adjustable temperature setpoint value that must be required by the user.

This register can be read (Modbus function 3 or 4) or written (Modbus functions 6 or 16). A remote controller connected to the Toshiba indoor unit will report the same temperature setpoint value as this register.

- **AC unit temperature reference (R)**

(register 5 – in Protocol address / register 6 – in PLC address):

This register reports the temperature that is currently used by the Toshiba indoor unit as the reference of its own control loop.

If the value on the register 22 is valid (different from 0x8000), it will report the value from this register. If not, it will show the indoor unit reference temperature.

It is a read-only register (Modbus functions 3 or 4).

Depending on the mode selected, the register shows a different value:

Heat Mode:

Temperature reference = Ambient temperature +0.5°C

Dry Mode / Fan Mode / Cool mode:

Temperature reference = Ambient temperature -0.5°C

When the mode changes from Heat to anyone else, or from anyone else to Heat, the register updates the value using the intervals +0.5°C/-0.5°C

- **AC unit external temperature reference (Modbus) (R/W)**

(register 22 – in Protocol address / register 23 – in PLC address):

This register reports the temperature from an external sensor in the Modbus side. If valid value is received, the Modbus register will indicate a 0x8000 value.

This register can be read (Modbus function 3 or 4) or written (Modbus functions 6 or 16).

- **AC Real temperature setpoint (R)**

(register 23 – In Protocol address / register 24 – in PLC address):

This register will show the same value as in register 4 (protocol address). The reference temperature from the remote controller is sent directly to the AC unit to be applied in the control loop.

It is a read-only register (Modbus functions 3 or 4).

Moreover, notice that temperature's values of all these four registers are expressed according to the temperature's format configured through its onboard DIP-Switches (See "4.4 - DIP-switch Configuration Interface"). These following formats are possible:

- **Celsius value:** Value in Modbus register is the temperature value in Celsius (i.e. a value "22" in the Modbus register must be interpreted as 22°C)
- **Decicelsius value:** Value in Modbus register is the temperature value in decicelsius (i.e. a value "220" in the Modbus register must be interpreted as 22.0°C)
- **Fahrenheit value:** Value in Modbus register is the temperature value in Fahrenheit (i.e. a value "72" in the Modbus register must be interpreted as 72°F (~22°C)).

4.4 DIP-switch Configuration Interface

All the configuration values on TO-RC-MBS-1 can be written and read from Modbus interface. Otherwise, some of them can also be setup from its on-board DIP-switch interface. The device has DIP-switches SW1, SW3 and SW4 on the following locations:

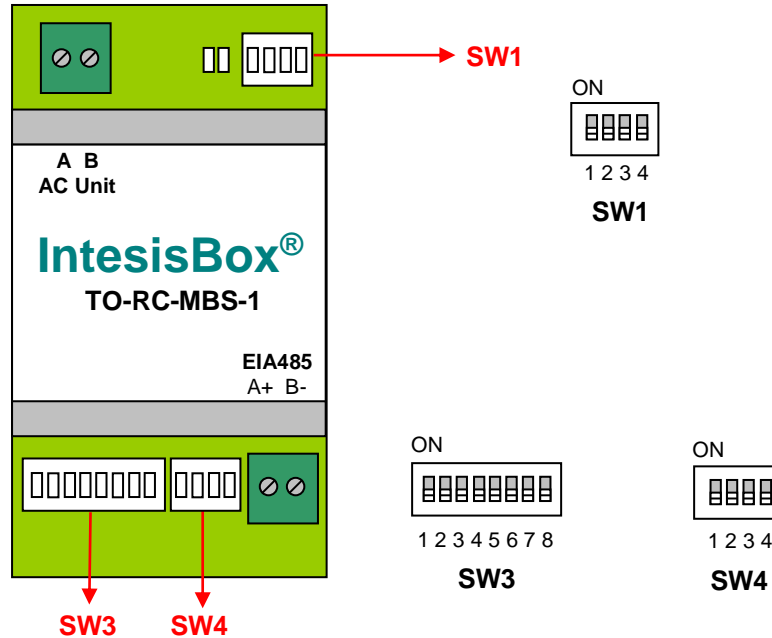

The following tables apply to the interface's configuration through DIP-switches:

SW1 – AC indoor unit's features

SW1-P1..2	Description
	Indoor Unit type not defined (Default value)
	Machine type: VRF-SMMSi
	Machine type: RAV
	Machine type: VRF-SMMS/SHRM
	Not used (Default value)
	Not used
	Not used (Default value)
	Not used

Table 4.1 SW1: AC indoor unit's features

SW3/SW4 – Baud rate configuration















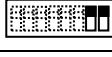

SW3-P7..8	SW4-P3	Description
		2400bps
		4800bps
		9600bps (Default value)
		19200bps
		38400bps
		57600bps
		76800bps
		115200bps

Table 4.2 SW3-SW4: Modbus baud rate

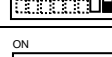
SW4 – Degrees/Decidegrees (x10), temperature magnitude (°C/°F) and EIA-485 termination resistor.

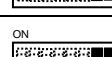





SW4-P1..2-4	Description
	Temperature values in Modbus register are represented in degrees (x1) (Default value)
	Temperature values in Modbus register are represented in Decidegrees (x10)
	Temperature values in Modbus register are represented in Celsius degrees (Default value)
	Temperature values in Modbus register are represented in Fahrenheit degrees
	EIA-485 bus without termination resistor (Default value)
	Internal termination resistor of 120Ω connected to EIA-485 bus

Table 4.3 SW4: Temperature and termination resistor configuration

SW3 – Modbus Slave address

Add	SW3-P1..6	Add	SW3-P1..6	Add	SW3-P1..6	Add	SW3-P1..6	Add	SW3-P1..6
0		13		26		39		52	
1		14		27		40		53	
2		15		28		41		54	
3		16		29		42		55	
4		17		30		43		56	
5		18		31		44		57	
6		19		32		45		58	
7		20		33		46		59	
8		21		34		47		60	
9		22		35		48		61	
10		23		36		49		62	
11		24		37		50		63	
12		25		38		51			

Table 4.4 SW3: Modbus slave address

4.5 Implemented Functions

TO-RC-MBS-1 implements the following standard Modbus functions:

- 3: Read Holding Registers
- 4: Read Input Registers
- 6: Write Single Register
- 16: Write Multiple Registers (Despite this function is allowed, the interface does not allow to write operations on more than 1 register with the same request, this means that length field should be always be 1 when this function is being used in case of writing)

4.6 Device LED indicator

The device includes two LED indicators to show all the possible operational states. In the following table there are written the indicators which can be performed and their meaning.

L1 (green LED)

Device status	LED indication	ON / OFF Period	Description
During not normal operation	LED blinking	500ms ON / 500ms OFF	Communication error
During normal operation	LED flashing	100ms ON / 1900ms OFF	Normal operation (configured and working properly)

L2 (red LED)

Device status	LED indication	ON / OFF Period	Description
During not normal operation	LED Pulse	3sec ON / --- OFF	Under voltage

L1 (green LED) & L2 (red LED)

Device status	LED indication	ON / OFF Period	Description
During normal operation	LED Pulse	5sec ON / --- OFF	Device Start-up
During not normal operation	LED alternatively blinking	500ms ON / 500ms OFF	EEPROM failure

4.7 EIA-485 bus. Termination resistors and Fail-Safe Biasing mechanism

EIA-485 bus requires a 120Ω terminator resistor at each end of the bus to avoid signal reflections.

In order to prevent fail status detected by the receivers, which are "*listening*" the bus, when all the transmitters' outputs are in three-state (high impedance), it is also required a fail-safe biasing mechanism. This mechanism provides a safe status (a correct voltage level) in the bus when all the transmitters' outputs are in three-state. This mechanism must be supplied by the Modbus Master.

The TO-RC-MBS-1 device includes an on-board terminator resistor of 120Ω that can be connected to the EIA-485 bus by using DIP-switch SW4.

Some Modbus RTU EIA-485 Master devices can provide also internal 120Ω terminator resistor and/or fail-safe biasing mechanism (Check the technical documentation of the Master device connected to the EIA-485 network in each case).

5. Electrical and Mechanical features

Enclosure	Plastic, type PC (UL 94 V-0) Net dimensions (dxwxh): 93 x 53 x 58 mm / 3.7" x 2.1" x 2.3" Color: Light Grey. RAL 7035	Operation Temperature	0°C to +60°C
Weight	85 g.	Stock Temperature	-20°C to +85°C
Mounting	Wall DIN rail EN60715 TH35.	Operational Humidity	<95% RH, non-condensing
Terminal Wiring (for low-voltage signals)	For terminal: solid wires or stranded wires (twisted or with ferrule) 1 core: 0.5mm ² ... 2.5mm ² 2 cores: 0.5mm ² ... 1.5mm ² 3 cores: not permitted	Stock Humidity	<95% RH, non-condensing
Modbus RTU port	1 x Serial EIA485 Plug-in screw terminal block (2 poles): A, B Compatible with Modbus RTU EIA-485 networks	Isolation voltage	1500 VDC
AC unit port	1 x AB bus Plug-in screw terminal block (2 poles): A, B Compatible with Toshiba networks	Isolation resistance	1000 MΩ
Switch 1 (SW1)	1 x DIP-Switch for AC features	Protection	IP20 (IEC60529)
Switch 3 (SW3)	1 x DIP-Switch for Modbus RTU settings	LED indicators	2 x Onboard LED - Operational status
Switch 4 (SW4)	1 x DIP-Switch for extra functions		

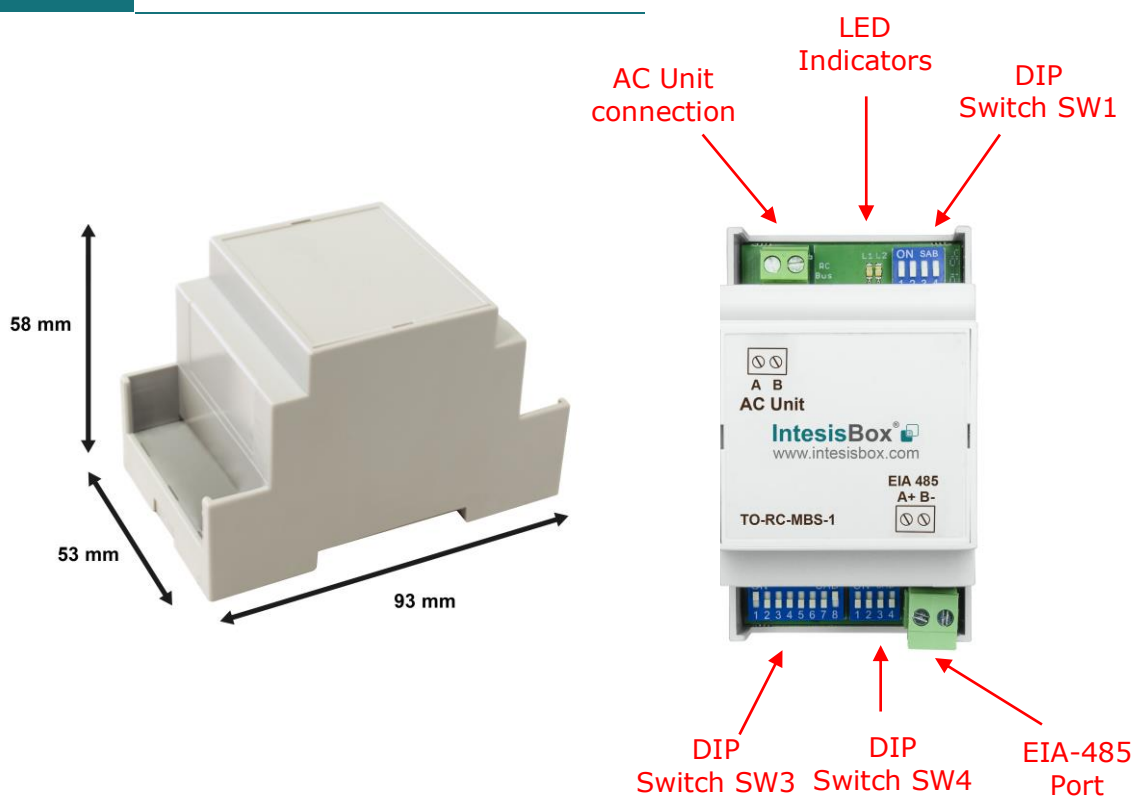

6. List of supported AC Unit Types.

A list of Toshiba indoor unit model references compatible with TO-RC-MBS-1 and their available features can be found in:

https://www.intesisbox.com/intesis/support/compatibilities/IntesisBox_TO-RC-xxx-1_Compatibility.pdf

7. Error Codes

Error Code Decimal	Error Code Hex	Error in Remote Controller	Error category	Error Description
0	0	N/A	TO-RC-MBS-1	No active error
33	21	C01	Central Controller Issues	Duplicated setting of control address
34	22	C02		Central control number of units mis-matched
35	23	C03		Incorrect wiring of central control
36	24	C04		Incorrect connection of central control
37	25	C05		System Controller fault, error in transmitting comms signal, i/door or o/door unit not working, wiring fault
38	26	C06		System Controller fault, error in receiving comms signal, i/door or o/door unit not working, wiring fault, CN1 not connected correctly
44	2C	C12		Batch alarm by local controller
48	30	C16		Transmission error from adaptor to unit
49	31	C17		Reception error to adaptor from unit
50	32	C18		Duplicate central address in adaptor
51	33	C19		Duplicate adaptor address
52	34	C20		Mix of PAC & GHP type units on adaptor
53	35	C21		Memory fault in adaptor
54	36	C22		Incorrect address setting in adaptor
55	37	C23		Host terminal software failure
56	38	C24		Host terminal hardware failure
57	39	C25		Host terminal processing failure
58	3A	C26		Host terminal communication failure
60	3C	C28		Reception error of S-DDC from host terminal
61	3D	C29		Initialization failure of S-DDC
63	3F	C31	Configuration change detected by adaptor	
65	41	E01	Addressing and Communication Problems	Remote control detecting error from indoor unit, Address not set/Auto address failed. Check interconnecting wiring etc. Re-address system.
66	42	E02		Remote detecting error from indoor unit,
67	43	E03		Indoor unit detecting error from remote,
68	44	E04		Indoor seeing error from outdoor. Qty of i/d units connected are less than qty set. Check; all i/d units are ON, reset turn off all units wait 5min power up
69	45	E05		Indoor unit detecting error from outdoor unit, Error in sending comms signal
70	46	E06		Outdoor unit detecting error from indoor unit, Error in receiving comms signal
71	47	E07		Outdoor unit detecting error from indoor unit, Error in sending comms signal
72	48	E08		Incorrect setting indoor/controller, Indoor address duplicated
73	49	E09		Incorrect setting indoor/controller, Remote address duplicated or IR wireless controller not disabled
74	4A	E10		Indoor unit detecting error from 'option' plug, Error in sending comms signal
75	4B	E11		Indoor unit detecting error from 'option' plug, Error in receiving comms signal
76	4C	E12		Auto addressing failed, Auto address connector CN100 shorted during auto addressing
77	4D	E13		Indoor unit failed to send signal to remote controller
78	4E	E14		Setting Failure, Duplication of master indoor units

79	4F	E15	Addressing and Communication Problems	Auto addressing failed, Number of indoor units connected are less than number set
80	50	E16		Auto addressing failed, Number of indoor units connected are more than number set
81	51	E17		Group control wiring error, Main indoor unit not sending signal for sub indoor units
82	52	E18		Group control wiring error, Main indoor unit not receiving signal for sub indoor units
83	53	E19		Outdoor header units quantity error
84	54	E20		Auto addressing failed, No indoor units connected
87	57	E23		Sending error in communication between outdoor units
88	58	E24		Auto addressing failed, Error on sub outdoor unit
89	59	E25		Auto addressing failed, Error on outdoor unit address setting
90	5A	E26		Auto addressing failed, Quantity of main and sub outdoor units do not correspond to the number set on main outdoor unit P.C.B.
92	5C	E28		Follower outdoor unit error
93	5D	E29		Auto addressing failed, Sub outdoor unit not receiving comms for main outdoor unit
95	5F	E31		Between units, Comms failure with MDC, does E31 remain after power is re-instated? If so replace PCB. & power PCB
97	61	F01		Sensor Faults
98	62	F02	Indoor Heat Exch freeze temp sensor failure (E2)	
99	63	F03	Indoor Heat Exch outlet temp sensor failure (E3)	
100	64	F04	Outdoor Discharge temp sensor failure (TD) or (DISCH1)	
101	65	F05	Outdoor Discharge temp sensor failure (DISCH2)	
102	66	F06	Outdoor Heat Exch temp sensor failure (C1) or (EXG1)	
103	67	F07	Outdoor Heat Exch temp sensor failure (C2) or (EXL1)	
104	68	F08	Outdoor Air temp sensor failure (TO)	
106	6A	F10	Indoor inlet temp sensor failure	
107	6B	F11	Indoor outlet temp sensor failure	
108	6C	F12	Outdoor Intake sensor failure (TS)	
109	6D	F13	GHP - Cooling water temperature sensor failure	
111	6F	F15	Outdoor temp. sensor misconnection (TE1,TL)	
112	70	F16	Outdoor High pressure sensor failure	
113	71	F17	GHP - Cooling water temperature sensor fault	
114	72	F18	GHP - Exhaust gas temperature sensor fault	
116	74	F20	GHP Clutch coil temperature fault	
119	77	F23	Outdoor Heat Exch temp sensor failure (EXG2)	
120	78	F24	Outdoor Heat Exch temp sensor failure (EXL2)	
125	7D	F29	Indoor EEPROM error	
126	7E	F30	Clock Function (RTC) fault	
127	7F	F31	Outdoor EEPROM error	
129	81	H01	Compressor Issues	Compressor Fault, Over current (Comp1)
130	82	H02		Compressor Fault, Locked rota current detected (Comp1)
131	83	H03		Compressor Fault, No current detected (Comp1)
132	84	H04		Comp-1 case <i>thermo</i> operation
133	85	H05		Compressor Fault, Discharge temp not detected (Comp1)
134	86	H06		Compressor Fault, Low Pressure trip
135	87	H07		Compressor Fault, Low oil level
136	88	H08		Compressor Fault, Oil sensor Fault (Comp1)
139	8B	H11		Compressor Fault, Over current (Comp2)
140	8C	H12		Compressor Fault, Locked rota current detected

				(Comp2)
141	8D	H13		Compressor Fault, No current detected (Comp2)
142	8E	H14		Comp-2 case <i>thermo</i> operation
143	8F	H15		Compressor Fault, Discharge temp not detected (Comp2)
144	90	H16		Oil level detection circuit error / Magnet switch error / Overcurrent relay error
149	95	H21		Compressor Fault, Over current (Comp3)
150	96	H22		Compressor Fault, Locked rota current detected (c.3)
151	97	H23		Compressor Fault, No current detected (Comp3)
153	99	H25	Compressor Issues	Compressor Fault, Discharge temp not detected (Comp3)
155	9B	H27		Compressor Fault, Oil sensor fault (Comp2)
156	9C	H28		Compressor Fault. Oil sensor (connection failure)
159	9F	H31		Compressor Fault. IPM trip (IMP current on temperature)
193	C1	L01		Incorrect Settings
194	C2	L02	Setting Error, Indoor/outdoor unit type/model miss-matched	
195	C3	L03	Duplication of main indoor unit address in group control	
196	C4	L04	Duplication of outdoor unit system address	
197	C5	L05	2 or more controllers have been set as 'priority' in one system - shown on controllers set as 'priority'	
198	C6	L06	2 or more controllers have been set as 'priority' in one system - shown on controllers not set as 'priority'	
199	C7	L07	Group wiring connected on and individual indoor unit	
200	C8	L08	Indoor unit address/group not set	
201	C9	L09	Indoor unit capacity code not set	
202	CA	L10	Outdoor unit capacity code not set	
203	CB	L11	Group control wiring incorrect	
205	CD	L13	Indoor unit type setting error, capacity	
207	CF	L15	Indoor unit paring fault	
208	D0	L16	Water heat exch. unit setting failure	
209	D1	L17	Miss-match of outdoor unit with different refrigerant	
210	D2	L18	4-way valve failure	
211	D3	L19	Water heat exch. unit duplicated address	
212	D4	L20	Duplicated central control addresses	
213	D5	L21	Gas type setup failure	
220	DC	L28		Maximum number of outdoor units exceeded
221	DD	L29		No. of IPDU error
222	DE	L30		Auxiliary interlock in indoor unit
223	DF	L31		IC error
225	E1	P01	Indoor Unit Problems	Indoor unit fault, Fan motor thermal overload
226	E2	P02		Outdoor unit fault, Compressor motor thermal overload, over or under voltage
227	E3	P03		Outdoor unit fault, Compressor discharge temperature too high (Comp1) over 111 °C. Low on ref gas, exp. valve, pipework damage.
228	E4	P04		Outdoor unit fault, High pressure trip
229	E5	P05		Outdoor unit fault, Open phase on power supply. Check power on each phase, inverter PCB, control PCB
231	E7	P07		Heat sink overheat error
233	E9	P09		Indoor unit fault, Ceiling panel incorrectly wired
234	EA	P10		Indoor unit fault, Condensate float switch opened

235	EB	P11		GHP - Water Heat exch. low temp (frost protection) fault
236	EC	P12		Indoor unit fault, Fan DC motor fault
237	ED	P13		Outdoor liquid back detection error
238	EE	P14		Input from leak detector (If fitted)
239	EF	P15		Refrigerant loss, high discharge temp and EEV wide open and low compressor current draw.
240	F0	P16		Outdoor unit fault, Open phase on compressor power supply
241	F1	P17		Outdoor unit fault, Compressor discharge temperature too high (Comp2) over 111°C. Low on ref gas, exp. valve, pipework damage.
242	F2	P18		Outdoor unit fault, By-pass valve failure
243	F3	P19		Outdoor unit fault, 4 way valve failure, i/door temp rises in cooling or fills in heating. Check wiring, coil, PCB output, valve operation.
244	F4	P20		Ref gas, high temp/pressure fault, heat exch. temp high C2, 55-60 °C, cooling over-load, sensor fault.
246	F6	P22		Outdoor unit fan motor fault, fan blade jammed, check connections, does fan turn freely, motor resistance 30-40ohm on each pair, no fan fault, yes PCB fault.
250	FA	P26		Outdoor unit fault, Compressor overcurrent - check winding resistance, Inverter failure - check internal resistance term HIC + & - to UVW 200-300Kohm or more
252	FC	P29		Outdoor unit fault, Inverter circuit fault - Motor-current Detection Circuit (MDC) fault, check comp windings, sensors C1 & TS, if ok possible PCB failure.
253	FD	P30		Indoor unit fault, System controller detected fault on sub indoor unit
255	FF	P31		Simultaneous operation multi control fault, Group controller fault
65535 (-1)		N/A	TO-RC-MBS-1	Error in the communication of TO-RC-MBS-1 with the AC unit

In case to detect an error code not listed, contact your closest Toshiba technical support service.